

# Developments IN THE IRON AND STEEL INDUSTRY During 1948

By I. E. MADSEN

▲ 1948 was another year of full time production, of increasing pressure for more steel as well as a continuous scramble for raw materials and equipment to keep the industry going at capacity. There were, perhaps, no outstanding revolutionary developments during the year; there were, however, a continuous series of planned improvements, plant additions, and modifications to increase capacity and to produce better steel as well as to attain more efficiency in production. These changes, small as each individual one might be, increased the ability of the industry to produce steel economically more than any of the more spectacular developments such as the use of oxygen. At the same time, these changes were accomplished without loss of production or dislocation of the production pattern.

The year also showed an acceptance by the industry of the necessity for expansion which was a change from the position of the previous year. These expansions, however, are being developed in an orderly planned sequence by the industry itself so as to minimize shortages of materials for expansion and for the making of steel. The result of the national election will undoubtedly have an effect on the expansion program. Although risk capital in many industries may be discouraged, there is a group in the top governmental policy levels who undoubtedly will push for increased capacity if the industry itself does not see fit to provide such an increase, and legislation will undoubtedly be attempted to enable the government to sponsor additional capacity. This group in the government has been recommending an increase in capacity of at least 10,000,000 tons. Such an expansion would require a minimum of 2,000,000 to 3,000,000 tons of steel just to build it. In addition, such a program would also be somewhat dependent on developing additional sources of ore (12,000,000 tons per year) and at present prices would cost about \$300.00 per ton or a total of \$3,000,000,000. The Department of Commerce has estimated that a 10,000,000 ton expansion program would require annually 10,900,000 net tons of iron ore, 7,070,000 net tons of coke, 6,890,000 net tons of pig iron. Their estimate as to the finished steel required for this expansion are one and one-half million to two million tons of steel. The government also estimates construction costs at \$250.00 per ton.

It is expected that by the end of 1949 the capacity of

the industry will be about 98,000,000 ingot tons per year.

One significant trend in the industry is illustrated by the capacity of the Pittsburgh district which from 1945 to 1948 decreased from 22,521,000 to 20,829,000 tons or on a percentage basis from 23.58 to 22.10 per cent. On the other hand, the Chicago district increased on a percentage basis from 19.8 to 20.01 per cent. This is an indication of the gradual movement of the industry westward. There is one exception to the pattern; the Philadelphia district increased its steel capacity in the same period from 10,784,000 to 11,505,000 tons, thus raising its percentage from 11.29 to 12.21.

Steel productive capacity in the west increased during the year, not only in terms of actual tonnage but also on a percentage basis. The completion of the present program of western facilities will bring steel production up to about 3,000,000 net tons of finished steel annually, three times more than the 900,000 net tons which were available before World War II.

If additional capacity is built, one of the big problems will be where it should be situated. It is possible that the development of Labrador ore fields as well as fields in South America would make it economical to set this capacity on the eastern seaboard or the Gulf Coast. On the other hand, if the St. Lawrence Canal should go through, a site on the Great Lakes might give the most economical transportation cost for ore, limestone, and fuel, as well as proximity to the larger markets.

Typical of the expansion plans of the industry is one just announced by Inland Steel Co., who plan to increase ingot capacity from fifteen to twenty per cent without additional furnaces or mills. The increase will be accomplished by enlarging existing furnaces, re-located, by installing heavier equipment such as cranes, ladles, etc., and by expanding the use of oxygen in the open hearth. This company's capacity for the production of tin plate and other tin mill products will be increased from 4,000,000 to 6,000,000 boxes per year by the addition of new and more efficient facilities and the addition of an electrolytic tinning line.

Among the additional facilities which went into production during the year were two new modern blast furnaces which were blown in at the Carnegie-Illinois Steel Corp.'s South Works in Chicago. This company



Shown in the background are two of the newest and largest blast furnaces which were just put into operation at the South Chicago works of the Carnegie-Illinois Steel Corp. These two furnaces can each produce 1500 tons of iron a day and are part of United States Steel Corp.'s \$875,000,000 post war development program.

also increased finishing facilities for silicon steel at Vandergrift, Pa., where two new continuous coil annealing lines went into operation. The Carnegie-Illinois Steel Corp. modernized some of their facilities at the Irvin Works thus increasing their cold rolled strip capacity. A similar increase was also made at Gary. A new coke oven battery installation was made at Clairton. The large construction program by the National Tube Co. which is going on at Lorain, Ohio was not completed during the year and will probably continue well into 1949. The National Tube Co. also installed additional tube-making facilities at Gary. At the Fairfield Works of Tennessee Coal Iron and Railroad Co., a hot rolled mill was converted to cold reduction. A new cold strip mill was completed by the Columbia Steel Co. at Pittsburg, Calif.

Most of the expansion program of the Bethlehem Steel Co. was completed. At Sparrows Point, a battery of coke ovens, a blast furnace, soaking pits, power station and new rolling mill equipment were installed. A coke oven battery and sintering plant were completed at Johnstown.

Republic Steel Corp. completed additional stainless steel cold finishing facilities at Massillon, Ohio, and also

completed installation of top pressure blowing on several additional blast furnaces, so that five are now so equipped, including furnaces at Buffalo and Warren. A new pipe mill was also completed at Gadsden, Ala.

Jones and Laughlin Steel Corp. added a new open hearth at their Otis Works. They also announced extensive remodeling of their facilities in the Pittsburgh area and six new open hearths will be installed at the South Side plant and obsolete facilities will be taken out of production.

Wheeling Steel Corp. is reconditioning two blast furnaces at the Mingo plant which they purchased from Carnegie-Illinois Steel Corp. New coke ovens were also installed, and a new butt weld pipe mill was just about completed during the year.

One of the interesting changes in the industry seems to be a trend towards integration, making them less susceptible to shortages of component materials. The trend towards consumer-owned steel plants also continued during the past year with the sale of several independent plants to consumer companies. An example of this was the purchase of the Phoenixville plant of the Phoenix-Apollo Steel Co. by the Kaiser Co., Inc., in order to produce steel for their automobiles. In the



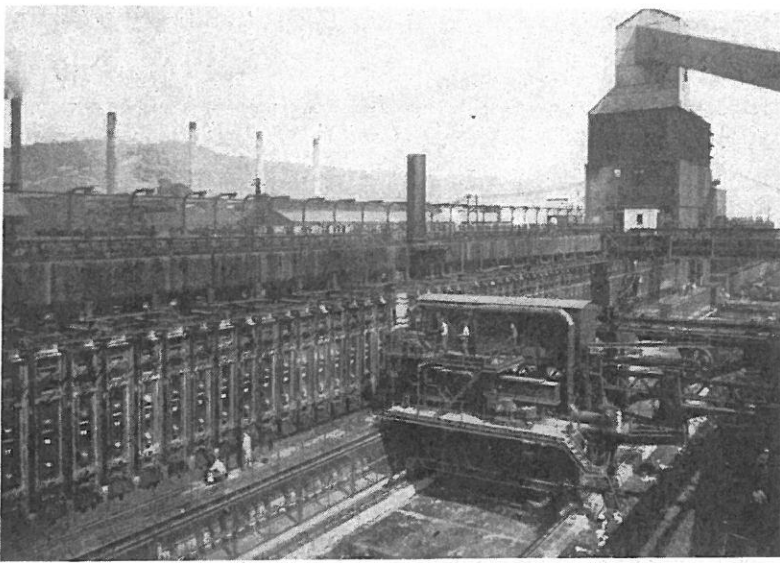

**Orderly expansion of steel capacity necessitates expansion of raw material production for the making of steel. The photograph shows a new battery of 106 coke ovens which was completed at the Jones and Laughlin Steel Corp.'s Aliquippa works in 1948. New batteries have been and are now being constructed at a number of steel plants.**

future, developments of this sort may occur in the electric furnace field because such units, carefully selected, can be shut down and started up much more economically than the open hearth, and thus they can match the ups and downs of end product production.

Among the consumers who obtained steel mill equipment is the Hudson Motor Car Co., which leased two-thirds of the former Shenango tin plate plant of Carnegie-Illinois Steel Corp. at New Castle, Pa. The Tucker Corp. attempted without success to get the DPC No. 5 furnace at Cleveland but this was leased by the Kaiser Co.

Both pig iron and steel capacity of the industry increased during the year. In December 1948, the American Iron and Steel Institute listed the first detailed statistics on the changes which have taken place in the steel industry since the end of the war. Steelmaking capacity as of January 1, 1948, was rated as 94,233,460 tons, which is an increase of about 3,000,000 tons from the beginning of the previous year. However, additional capacity came into being during the year and operating rates of 100 and slightly over 100 per cent during the later part of 1948 were due to a certain degree to this additional capacity. Blast furnace capacity on January 1, 1948 stood at an all time peak of 67,438,930 net tons, which exceeds even the war time high when many obsolete stacks were included in the figure. This was an increase of about one and three-fourth million tons compared with the previous year. On January 1, 1949, blast furnace capacity was about 70,500,000 tons, and steel capacity was about 96,000,000 tons.

Additional coke producing capacity was required before the additional blast furnace capacity could be utilized, and on January 1, 1948 coke capacity was 62,505,840 net tons for a new high. This increase in coke oven capacity was accomplished in spite of the fact that a number of beehive ovens had been taken out of service. As of a year ago, the remaining 3,790 beehive ovens in service had a capacity of 2,806,350 tons.

New figures for finished steel capacity also became available in the latter part of the year. These figures

were based on the so-called practical method of compiling data which takes into account quantity of raw steel which is available. Hot rolled steel capacity is now given as 73,872,430 net tons as of January 1, 1948. The trend towards lighter steel products shows up in the increased capacity of the industry to produce sheets and strip, for which the capacity at the present time is 26,500,000 tons, 5,000,000 tons more than five years ago.

Steel production in 1948 established new peacetime records, with production for the year totaling about 88,500,000 tons. If it had not been for the coal strike in the early part of the year, it is possible that a new all time peak would have been attained. Iron production in 1948 was about 59,000,000 tons, or 90 per cent of capacity. This compares well with the peak production of 62,072,683 tons attained during wartime 1944.

Shipments of finished steel for 1948 were about 65,700,000 tons. This compares well with a figure of 65,800,000 tons shipped in 1944, when almost 90,000,000 tons of ingots were produced. This trend is significant, as it indicates that the industry is attaining a higher yield, thus gaining the equivalent of additional capacity at no cost in terms of critically needed equipment or raw materials.

Production throughout the year was accompanied with the usual shortages of material, although scrap was in better supply than the previous year and coal quality was better. It is estimated that the industry in 1949 will produce about 68,000,000 tons of finished steel, out of a total ingot production of 92,000,000 tons, if no unexpected stoppages occur.

Steel demand continued strong, although towards the latter part of the year there seemed to be an inclination on the part of many consumers to get their supplies from regular sources and to avoid gray markets and high cost conversion deals. Unless the United States is involved in an extensive European rearmament program, the gap between supply and demand should be narrowed considerably in 1949.

The automobile industry held first place among industrial consumers of steel and approximately 15 per cent of the total shipments went to this industry. The construction industry took about 11½ per cent, rail transportation took 7.9 per cent and the oil and gas industry took a little over 6 per cent. Household appliances took about 3 per cent.

Steel prices continued their upward trend during the year and the composite steel price at the end of the year was about \$95.50 a ton which corresponds to \$76.09 one year ago. One item also which affected price was the fact that the industry changed from a gross ton to a net ton basis for quoting during the year. Scrap prices increased from \$40.00 to \$43.00. The composite pig iron price was about \$46.82 per gross ton at the end of the year compared with \$37.06 at the beginning of the year.

For the first time in the history of the steel industry a western mill announced prices which were at a parity with those of similar products produced in the east. This was done by a United States Steel Corp. subsidiary on May 1st.

Price increases were largely due to increases in operating and material costs. As an example, from figures reported in 1948, maintenance and repair changes in the industry were higher than ever before in history and \$692,200,000 were spent in 1947 which was 41.3 per cent

higher than in 1946. This corresponds to \$10.46 per ton of hot rolled iron and steel products.

One factor affecting steel costs was the growing scarcity of many non-ferrous raw materials. Aluminum, which in 1947 had started to catch up with demand again became a scarce item. One reason for this was the power shortage which reduced the production of ingots. Both copper and lead supplies became more critical and as a result the price of these two commodities increased during the year. Government stock piling was also a factor in these increases. Tin production increased during the year and its status remained about the same. Zinc supplies were tightened and this was particularly due to stockpiling.

One of the increasingly important trends in steel products in 1948 was the adoption of standards by the industry. The work of committees of the American Iron and Steel Institute in simplification of steel composition and products resulted in a number of standards being issued during the year. These standards were determined from tonnage studies on the order books of the steel companies, and their adoption enabled long tonnage runs of given commodities, thus helping to maintain a higher production rate than would have been possible if a larger variety of products were manufactured. A number of the national emergency low alloy steels were also standardized, and their production runs from ten to fifteen per cent of all the alloy steel products. Their use also is a result of the idea of specifying steel to hardenability limits rather than to chemical compositions.

One event which occurred during the year, although

#### Sintering is becoming more important in iron production.

In this illustration the iron ore mixed with coal dust is ignited in a sintering furnace. It will emerge from the process looking like lumps of coke which can be used in the blast furnace.

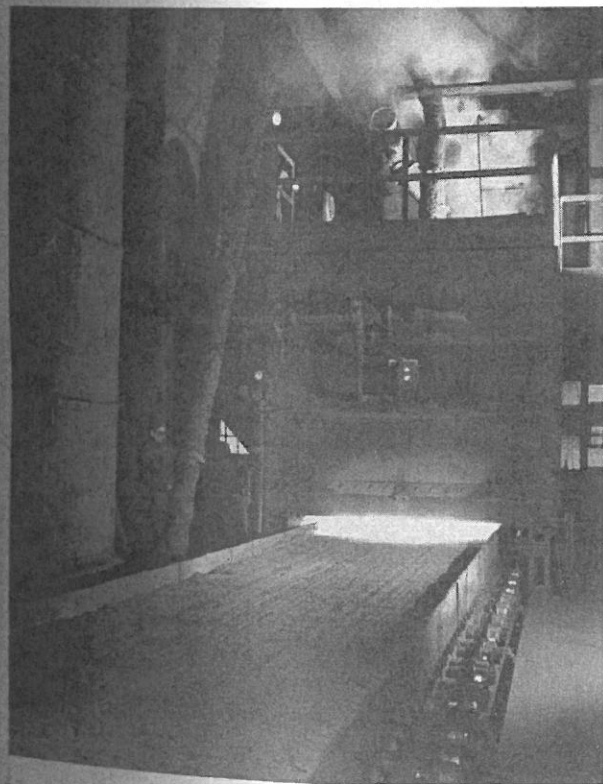

not a technical development, will undoubtedly have much more marked effect on the development of the industry than any other development for many years. This was the change in the pricing system which most of the industry saw fit to adopt after United States Supreme Court's ruling on the basing point system for the cement industry. Because of this ruling, steel producers adopted fob prices. As a result of this pricing system, when the demand for steel is slight and competition for markets become keen, the mill which is closest to the steel users will have an economical advantage over other mills. Unless otherwise influenced by raw materials and labor supplies, steel mill expansion and development will then be in areas where the steel is used, and as is now taking place, some users will move closer to their sources of steel supply. Areas such as Chicago and Detroit, where in normal times there is no appreciable surplus capacity for local markets, will have an advantage over areas such as Pittsburgh, where steel capacity is greater than local consumption.

Rail rates during the year continued an upward trend and, as a consequence, there was increased diversion of shipments to other forms of transportation, such as truck shipment and water-borne shipments. Another factor in this change is the fob pricing system. At the present time, truck hauls are now crowding rail hauls up to lengths of 600 miles.

Steel production increases were worldwide, and Europe attained a much higher and more efficient level of operation. The industry in Great Britain is also operating at one of the highest levels ever, with a rate of 15,000,000 tons per year. A very important factor, however, in the future of the British steel industry is the nationalization program which was introduced by the labor government in a bill in November. This bill calls for the nationalization of over 107 companies accounting for 90 per cent of the industry, and would bring under public ownership everything from digging of ore to rolling of steel. The owners will be paid with British iron and steel stock which is guaranteed by the treasury both as to principal and dividends. Share holders will receive stock equal in value to the stock exchange quotation based on the October, 1948, average, or that of the six months just before the 1945 election, whichever is the higher. Essentially, the bill changes a privately owned industry to a publicly owned monopoly. The industry in England has estimated that if a high level of employment continues, a capacity of 18,000,000 tons would be a reasonable requirement in the early 1950's.

In India, a plan was formulated to increase capacity, and under study are two new plants which would have an annual ingot capacity of 500,000 tons each. The increase in India's steel capacity will also be accompanied by expansion in railway, cement, coal and oil. In addition, the short term expansion program in that country plans additional development at Jamshedpur of 150,000 tons, 100,000 tons in Bengal, 36,000 tons in Mysore and 20,000 tons Ichapore, West Bengal. This will be done by expansions and improvements to present facilities.

The Broken Hill Proprietary Co. is planning a new hot and cold strip mill in Australia. The company will have to double its ingot capacity at Port Kembla, New South Wales, in order to supply this mill. The new plant will be the first to produce tin plate in Australia.



In the expansion in France a new blast furnace has been ordered for Acieries de Longway. A new strip mill is also under construction, and another is now planned. A new company has been organized in Belgium called S. A. Compagnie des Fers Blancs et Tubes a Froid. This company plans to introduce American methods of cold rolling sheet and tin plate.

In Poland, in Lower Silesia, Russian equipment is being used in steel plant construction and it has been estimated that Polish output will be doubled when this program is completed.

An American engineering and construction firm is making a survey for the Columbian government of the possibility of establishing a steel industry in that country. This is a continuation of the trend in South America towards local steel plants.

### BLAST FURNACES AND COKE PLANTS

Keeping the blast furnaces of the country going at capacity level was successfully accomplished because the ore suppliers were able to produce ores in the quantities, grades and qualities which were needed by the steel industry. The job was so well done that the carry-over of winter ore stocks from 1948 to 1949 was about 2,000,000 tons larger than that in 1948 and over 82,000,000 tons of ore were shipped to Great Lake ports during the year. In spite of these huge shipments, the fear of depletion of high-grade ores was reduced somewhat because of developments during the year on processes to beneficiate low-grade ores, as well as by the discovery and proving of new ore supplies such as those in Labrador and Venezuela. Total ore consumption during the year was about 98,000,000 gross tons.

More activity was probably present in the ore mining industry than ever before in its history, particularly in the development of the large reserves of low-grade ores in the Superior area. Although there are perhaps between one and two billion tons of high-grade reserves in this area, which is enough for fifteen to thirty years' supply, these reserves will probably last much longer than that because future practice may blend these ores with the lower grades. Construction of plants to concentrate lean ore is just starting and they are the beginning of what will probably be a huge industry employing large numbers of men, using great quantities of power, and requiring great amounts of capital for the investment needed in the processing equipment.

The taconite ores run about 30 per cent iron. Some of these ores are magnetic, so that magnetic methods can be used for separation. The taconites which are not magnetic will have to be concentrated by other means, and flotation appears to offer the best possibilities. However, as a result of these processes, the ore is too fine for use and the powder must be sintered in order to be used in blast furnace. One method recently developed for sintering will reduce costs to about 80 cents a ton from the present average on the range of about \$1.20 a ton. The method involves moistening the powder, and feeding it into a revolving drum that rolls it into pellets of iron. These are then put in ovens where they become hard enough to be charged into the blast furnace. However, the methods finally adopted may

differ a great deal from present methods because of new developments which may come out of the laboratories built during the past year. The Oliver Mining Co. just completed a new laboratory in Duluth, the Pickands Mather & Co. is continuing the work which they started in the laboratory in Hibbing in 1941, and the Cleveland Cliffs Iron Co. has a new laboratory under construction at Ishpeming. The M. A. Hanna Co. and the Jones & Laughlin Steel Corp. have both also finished new laboratories. A two million dollar experimental plant which will use the magnetic separation method at Aurora, Minn., was completed by Pickands, Mather & Co. This plant was designed to produce 200,000 tons of ore from taconite. The experimental unit built in 1945 by the Oliver Mining Co. treated about 350,000 tons of marginal ore during 1948.

In 1948 on the basis of an overall average, blast furnace ores had 50.42 per cent iron and 8.92 per cent silica. This compares with 51.80 per cent iron and 7.73 per cent silica in 1943. The trend has been gradual and uniform throughout this five year period. Sintering of ores has grown to a point where present sintering capacity is about 30,000,000 tons per year.

A large 4-unit beneficiation plant being contemplated is to be located near Beaver Bay on Lake Superior. It will be owned by the Reserve Mining Co. and managed by Oglebay-Norton & Co., and will be capable of producing ten million tons of taconite concentrate annually when all four units are completed. It has been estimated that the investment cost of the plant will run about \$16 per ton of annual capacity and the project will take 4 to 5 years to complete.

In this plant the taconite will be fed to a primary crusher from railroad cars. It will then pass through secondary crushers, rod mills, magnetic separators, wash boxes, surge tanks, filters, and then to the agglomeration plant. The tailings will be poured into Lake Superior, and forty tons of water will be required for each ton of sinter. It has been estimated also that 60 to 70 kw/hr will be required per ton of concentrate.

A great deal of work has been done in further developing ore supplies in the state of New York, and the indus-

**The magnetic ores lend themselves better to methods of concentration and this photograph shows fine particles of magnetic iron ore being separated from waste material at an open quarry mine at Star Lake, N. Y.**

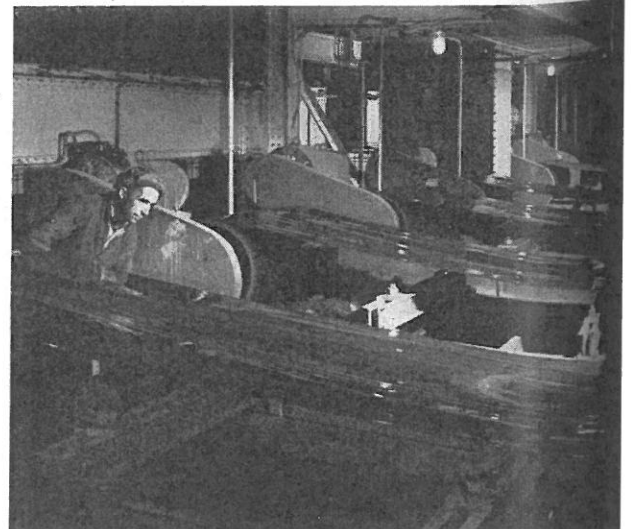

try in the Adirondacks has taken a new lease of life. New York state ranks third in iron production in the country, and the ore is chiefly magnetic. Both open pit and underground operations are being done. The world's largest open quarry mine for magnetite ore has been opened at Star Lake, N. Y. Here at the Benson Mines, output was about 800,000 gross tons. Since the ores here are in a very hard rock, they must be blasted into pieces, and then processed in a crusher. They are then further pulverized through additional crushers and through rod and ball mills and then magnetic separators are used. The product is then sintered and shipped to the blast furnaces. A new pilot plant is also being constructed for concentrating non-magnetic ores.

A second steel company is also doing a great deal of work on rock-ores at Port Henry, N. Y. The average ores run about 35 per cent metallic iron and ores with as little as 22 per cent iron content can be profitably concentrated. Several old workings in the area around Caledonia are being re-explored and it is possible that new ore deposits may be located in the area. Some of the ore in that region is practically free from phosphorous.

The Bureau of Mines recently estimated that the potential reserves in Iron County, Utah, consist of 500,000,000 long tons of iron ore. About 100,000,000 long tons of this can be conservatively classified as having 40 to 50 per cent iron and the same content may be inferred to be contained in an additional 250,000,000 tons.

During the past year, a great deal of work went on in proving and exploration of the Quebec-Labrador deposit. This exploration indicates that these fields offer extensive reserves of high-grade ores running better than 60 per cent iron. Most of the initial exploration covers only those areas where surface indications were present which offered possibilities for open pit mining. The project will require a railroad about five hundred miles long to tidewater at Seven Islands, Quebec, where

Separation of non-magnetic ores is a most difficult problem and shown here is an operation in a new pilot plant completed in 1948 at the Benson Mines, New York. The first of three stages of spiral concentration is illustrated where crude ore is carried down the spiral channels by wash water. The waste material is washed to the outer lip while the iron minerals work their way to the inner portion where they are tapped from the inside of the channel.



a harbor is available for the ocean-going vessels. Over 300,000,000 tons of ore proved so far show that the typical ore runs about 59 per cent iron, 1.50 per cent manganese, and 1.50 per cent silica.

Recent reports on the ore deposits in Minas Gerais, Brazil, indicate that the ore reserves here are much larger than ever previously estimated. One engineer claims that this ore is sufficient to feed the iron and steel furnaces of the world for the next 100 years. The ore runs from 60 to 70 per cent iron, is clean, reducible, free of moisture and can be moved and transported throughout the whole year. It is so located that it is only about twelve hours travel time from the ocean. A great deal of exploration work is still going on to determine the exact extent of these deposits.

At Mina El Pao, 168 miles up the Orinoco River in Venezuela, new reserves have been developed consisting of a high-grade hematite ore which runs about 69 per cent iron, is low in phosphorous and free of vanadium and titanium. It is expected that shipping out of this area will begin by the end of 1949. A short railroad must be constructed as well as river transportation facilities. The recent revolution may alter some of these estimates. However in general, it is believed that the development of such mining operations in South America will help the national economies of the countries, and stabilize their governments.

Except during the period of the coal strike, adequate coal was available throughout the year for the industry. Because of the continued mechanization of the mines, coal quality as mined is gradually deteriorating, with ash and sulphur content on the increase. Hence, coal washing is being extended in the industry. However, research work sponsored by the coal industry tends to show that it is possible to use economically a higher sulphur coke in the blast furnace than has previously been thought possible. These preliminary conclusions are the result of a research program by the Coal Research Laboratory at the Carnegie Institute of Technology. The work also indicates that the rate of breakage is a better index of coke quality for blast furnace operation than the present test on coke breakage which is based on reduction in size. Under present blast furnace practice, coke is the item on which the closest control tests are constantly made. The other items which go into iron production, such as ore and limestone, are not constantly checked, with the result that coke is blamed for any variation in iron quality which may actually have been affected instead by variations in ore or limestone. If, on the other hand, the blast furnace is treated as a chemical retort with analyses made constantly on the limestone and ore as well as on the coke, such control would enable higher sulphur coke to be economically used in production.

Some coke plants felt that supplies of good quality coking coal were better during the year because of the substantial betterment of all coal supplies, and the increased use of coal washing equipment enabled better coal to be shipped even if the mined product was lower grade.

Heavy media suspensions are being used in the construction of a new large coal cleaning plant. The method is efficient in making preparations of coal which are high in impurities because it enables a separation of mate-



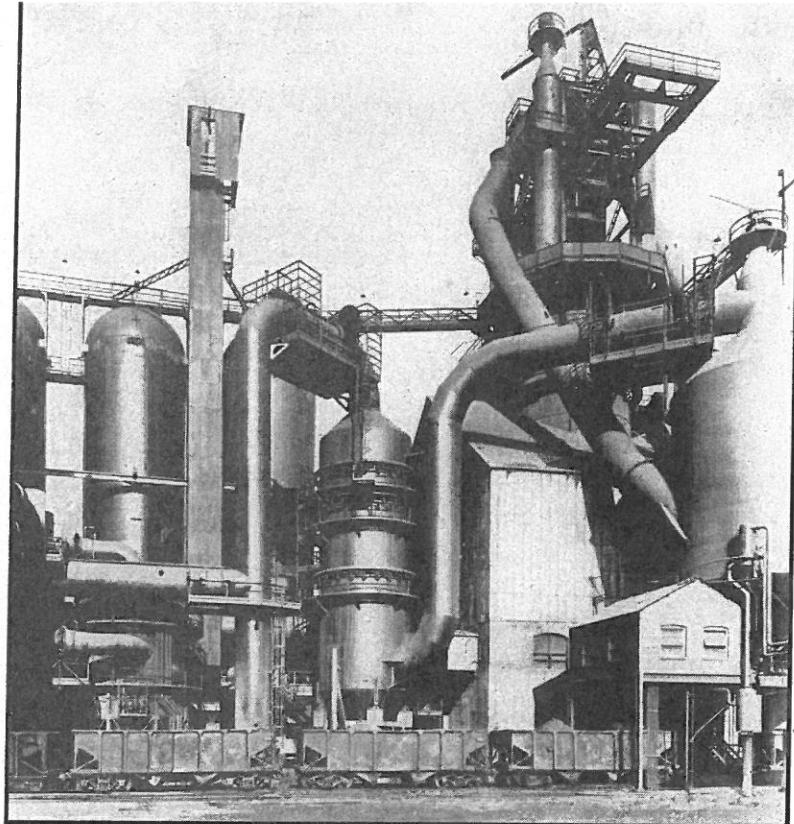

The favorable operating results being attained on blast furnaces with 10 psi top pressure indicate that results with 20 psi may be even more advantageous.

rials which have only slight differences in specific gravity, and this is the case for pure and impure coals. Heavy media suspensions employing water are used, as they are more economical than the usual heavy liquids. The method reduces coal loss, gives higher recovery and a cleaner product. This coal cleaning plant is designed to produce 18,000 tons of washed coal daily. More than 10,000 hp in electric motors is required to operate the plant.

A good deal of research is being sponsored on equipment to mine coal mechanically, and the bituminous coal industry launched a \$250,000 program last year to design a machine that will mine coal cheaper and faster. The object of the program is to develop a machine that will cut coal from the solid vein without the use of explosives and load it continuously into a conveyor or mine cars. Two such machines were demonstrated during the year.

One of the new continuous mining machines can dig and load soft coal at a rate of three tons or more a minute. This machine is mounted on a low tractor and has ten rotating cutting heads attached to the front. These cutting heads chip the coal from the mine face and, as the machine progresses, the loose coal is carried to the rear and moved by conveyors to the cars. Inasmuch as a recent report of the Bureau of Mines indicates that the average thickness of the coal in the country is 65 in., there should be ample opportunity to use the machine.

The other new continuous mining machine was recently demonstrated, operating on a coal seam 60 in. thick, and in one operation ripped out the coal and loaded it into a hopper car. This unit can mine coal

seams of 60 to 40 in. or less, while high models are available which will mine seams from 54 to 96 in. The machine is designed to mine two tons of coal per minute.

New blast furnace stacks completed during the year include those at the South Chicago Works of Carnegie-Illinois Steel Corp.; a new 1400-ton furnace for Youngtown Sheet and Tube Co. at Indiana Harbor; the Koppers Motor Co. "C" furnace at the Rouge plant, and the Pittsburgh Steel Company's furnace at Monessen. The two idle blast furnaces at the Mingo plant were modernized by the Wheeling Steel Corp. and returned to production. These have been idle for some time. A new 1200-ton blast furnace will be built by Henry Kaiser at his Fontana steel plant.

Since 1944 there has been a drop in the production of pig iron per square foot of hearth area, ranging for the major producing companies from 0.04 to 0.33 net tons per sq ft per day. The average loss is about 8 per cent or 80 tons per day for a 1000-ton furnace. This loss is largely due to the drop in coal quality over the years and to virtual elimination of scrap in the blast furnace. Since 1944 coal consumption has increased about 25 per cent. Ash content is now running about 10.8 per cent. The limestone required as a consequence has been increased from about 778 to about 812 pounds per ton of pig iron produced.

Some of the outstanding production performance have been reached in blast furnaces in the far West. At one plant, a monthly average coke rate of 1360 lb per ton of iron was reached in one month, and seldom has a coke rate been over 1450 lb per ton. These results are credited to proper raw material preparation.

Blast furnace men are now talking about the 2000-ton blast furnace, and they estimate that this furnace is not far away. Such production will probably be attained by the use of beneficiated ores under close control. Permeability of ore charge, bulk of the charge, reducibility of the ore and uniformity of chemical and physical properties of beneficiated materials must be taken into consideration in order to obtain this rate. The blast furnace would need about three stoves, each with 333,000 sq ft of heating surface. The stove required would probably have a larger diameter than those in present practice, since the checkerwork must withstand its own weight and for this reason the height should not exceed 100 ft. Blowers must furnish enough air to burn 1700 lb of coke per ton of iron and 125,000 cfm of air. Blowers would probably accomplish this result. Such a furnace would probably require a volume of 50,900 cu ft and as the retention time of the charge is 8½ hours, this will give a furnace with a hearth diameter of about 80 ft, a working height of the stack of about 86 ft, and an overall height of about 116 ft.

So far no results seem to be available in the United States on the use of oxygen in the blast furnace. One company, however, recently completed an oxygen plant, and the production of this plant will be used in blast furnace experimentation. Another company is building an oxygen plant which will be used in the blast furnaces as well as in the open hearth.

The use of high top pressure in blast furnaces continues, with seven furnaces now scheduled by one company for this operation. Another company also has started to convert two of its furnaces. One of the problems which accompanied high top pressure was excessive

sive erosion of bleeder valves. It has been found that the installation of a clean gas bleeder will ameliorate this condition. When the furnace slips, pressure is relieved by the clean gas bleeder through switch relays.

Turboblowers which have been delivered during the year will enable furnaces to be operated at 20 psi top pressure, which should get better results than the 10 psi used in most high pressure installations. For existing plants where it would not be economical to replace existing blowers, booster blowers may provide the answer.

One of the most interesting examples of oxygen enriched blast in the German iron and steel industry was at the Suddutsche Kalkstickstoff Werke in Trostberg. At this location a low shaft blast furnace was built. A low shaft furnace minimizes the cooling effect on the gases as they go up through the blast furnace. The gases cannot go below a low limit of approximately 212 to 250 F. When oxygen is added, because of the small amount of gas, cooling takes place more rapidly and in a low furnace oxygen content can be increased. A campaign lasting four weeks was run in this furnace producing pig iron. This campaign proved that the pig iron could be smelted successfully in such furnaces. Temperatures can be reached beyond those of the normal blast furnace (3350 F) and can go up to temperatures equivalent to those found in the electric furnace. It thus becomes possible to reduce metal oxides, which require the higher temperatures to iron ore.

Ores with lower contents of metals can be used economically. Lower grade fuels can also be used because of

the low height of the furnace and low weight of the burden. In addition, the costs of lifting the burden 20 ft would be much less than those for lifting it 100 ft. The blast furnace gases also are of higher quality than those of the normal blast furnace.

The trend in blast furnace linings is towards hard-fired refractories, superduty quality refractories, and carbon. The carbon is generally limited to the hearth. Superduty brick is generally being made of Missouri fire clays which fire to greater density than most other types. Actually, the fusion point is only about 20 to 35 F higher by actual measurement.

It is estimated that about 45 blast furnaces in the country now have some carbon in their hearth construction. The large carbon block is generally favored, with two layers forming the entire lining thickness. Operating results attained with carbon hearth linings still indicate that they will reduce breakouts, although there was a recent breakout in one lining shortly after it was installed.

In blast furnace stoves, a semi-silica type of refractory was more extensively used for domes, combustion chambers and top checkers. Jersey brick of this type was used for the first time in the Chicago district. The low alkali content permits this brick to withstand deformation better than regular brick.

An interesting detail developed for opening iron notches is called a jet caster. This has a projectile shaped top which contains a 2 oz charge of an explosive. The action is similar to that of a bazooka. If one shell does not bring the iron, a second charge is inserted in the notch and fired. It was estimated that a notch can be opened about \$1.00 cheaper than by the use of the oxygen lance.

The blast furnace revolving distributor has been completely redesigned and the new distributor support is furnished by three 18 ft diameter rollers with hardened alloy steel rims instead of the six bottom supporting rollers previously used. Lateral stability is provided by three side rollers and the top is held down by three top rollers which duplicate the supporting rollers. The sealing arrangement has been changed and is completely independent of the bell seat.

Shown here is a section through the low shaft blast furnace at Trostberg reported in Fiat final report No. 1203. All dimensions are metric.

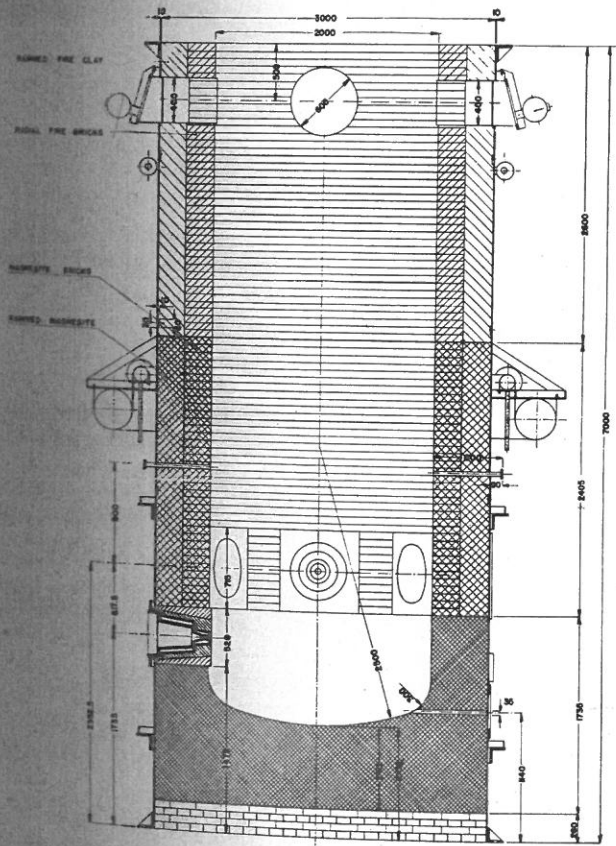

## STEELMAKING

The number of steelmaking furnaces in the United States as of January 1, 1948, showed an increase of 30 furnaces over the previous year. A total of 954 open hearth furnaces were in operation, with a total capacity of 83,610,690 tons. Thirty-nine bessemer converters, including ten which were used only for melting charges for open hearth furnaces were in production with an annual capacity of 5,226,000 tons. Electric furnace capacity was 5,396,770 tons with a total of 223 furnaces. Total capacity of the industry was 94,233,460 tons and this figure had increased appreciably by the end of the year.

Few companies in the industry were not experimenting with oxygen in one form or another in the open hearth. Practical limitations which showed up during the year made it evident that its use might not be as revolutionary as had been first indicated. There is no



denying, however, that oxygen is a very useful tool. By its use an operator can adjust temperatures quickly, and also speed up particular heats to avoid bunching. Limitations in charging, however, prevent operators from taking full advantage of the speed-up. In addition, limitations in finishing facilities, soaking pits, etc., in the case of balanced plants, mean that there might not be too much point in speeding up steel production, with the additional existing costs which this might entail, until the capacity of the rest of the plant could be balanced with the increased ingot capacity. Up to the present, most oxygen applications are used for carbon reduction in the bath by the use of the lance. There is some evidence also that there is some sulphur reduction with its use.

The use of oxygen for combustion seems to have a bad effect on furnace refractories. There is a definite need for better refractories. Some users believe that super-duty silica brick will withstand both the addi-

using oxygen on 94 heats. These tests indicated that when oxygen was used in the burner, oxygen should be injected for about two hours, starting when the scrap was about one-half charged and ending at the start of the hot metal charging. This limitation gave no loss in time and resulted in substantial savings in oxygen. Tests were made with a relatively constant charge consisting of 60 per cent hot metal, 33 per cent scrap and 7 per cent metallic ore. Five different burners were tested and enrichment up to 33 per cent oxygen was used. However, no gain resulted from using over a 27 per cent enrichment, and this latter percentage gave heats which were on the average 20 per cent faster and showed a fuel saving of 10 per cent. There was no unusual refractory wear. The heats averaged about 200 net tons. A number of other heats were also made in this plant and five different furnaces were used for a total of 400 heats in the test program. Furnace charges ranged from all cold up to 60 per cent hot metal. The corresponding oxygen

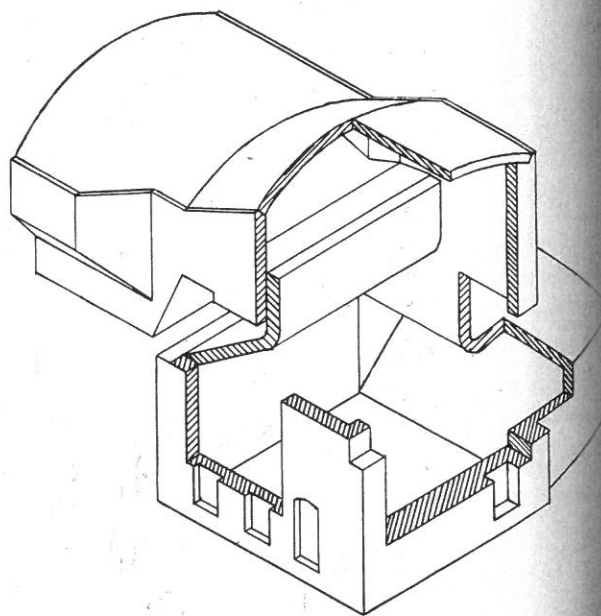
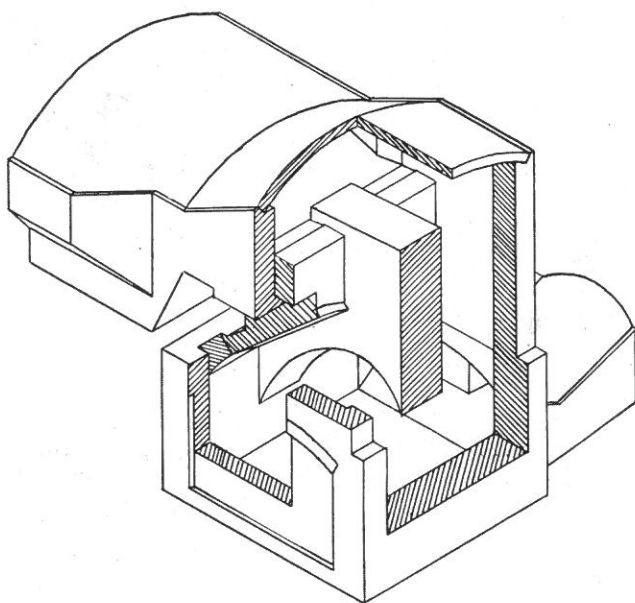

The conventional silica furnace is generally modified somewhat for conversion to basic construction. On the left is shown a cutaway section of the end of a conventional silica furnace and on the right is a cutaway view of the furnace converted to basic construction.

tional heat due to the oxygen as well as the splash from the slag when the lance is used in the bath.

Some plants believe that the use of compressed air, particularly for the steels with relatively high carbon content, is more economical than oxygen. In one plant compressed air was used in a test run of 34 heats limited to 0.4 to 0.7 per cent carbon rimmed and mechanical capped grades of steel. Air pressure was 48 psi. A 9.6 per cent reduction in charge to tap time, because of a 22.4 per cent reduction in melt to tap time, was found for the heats made with compressed air and production increased 10 per cent in tons per melting hour. Two pipes are usually used per heat and there was some noticeable erosion.

Supplementing the work which was reported last year are the results of a complete series of tests at a steel plant in which 241 test heats were made in one furnace,

consumption ranged from about 1200 cu ft per ton for cold charges to about 600 cu ft per ton for high metal charges.

Multiple burners have also been used to decrease melt time, particularly when high scrap charges are used. In one design, one burner is placed on top of the other and both are used during the meltdown period. After the scrap is melted, one burner is shut off. In one plant where multiple burners and compressed air were used, the second burner was so pitched that the center line of the flames converged between second and third doors. In order to avoid sweating the roof, this plant also resorted to single firing at the time that the scrap became nearly level. The initial test results gave an increase of 0.48 net tons per melting hour or 5.1 per cent or 0.42 tons per operating hour or 4.8 per cent. Compressed air was used from the beginning of charging.

until the scrap was well melted down. About 275 cu ft of air at 100 psi were used and because of the compression the air has a temperature of 200 F at the furnace. It was introduced through a 1 in. pipe positioned directly under the burner with the open end of the pipe flush with the burner face. After a year's experience with the double burners and compressed air heats averaging 104 tons, the net effect was an increase in production rate of 15 per cent with a 4 per cent reduction in melting fuel, which averaged 4,672,000 net Btu per net ton of ingots.

One steel plant expects to increase the output of its steelmaking facilities about 20 per cent when its oxygen plant is completed. In addition to the oxygen, it has been necessary to modernize the auxiliary facilities such as ladle cranes, etc.

One of the factors necessary in speeding up the open hearth process is to reduce the charging time. One plant has found that proper preparation of light scrap, reducing the number of boxes from 200 to 80, results in a saving in the charging time of 1½ to 2½ hours. At this same plant the use of oxygen saves from 1 to 1½ hours per heat during meltdown and refining. Other means of meeting this problem are by the use of as large a charging box as possible and the installation of archless door frames and basic front walls to enlarge the opening. In order to speed up charging, some companies have considered opening up the front of the furnace and charging on a continuous grate chain charger full car loads of scrap.

Charge and feed ores deteriorated in quality during the year, but imports of Mexican, Chilean, Brazilian and Swedish ores eliminated some of this problem. Ore from the Steep Rock development will probably also help this situation.

A number of plants have installed cupola furnaces in their open hearth shops and thus minimized some of their raw material problems. In a typical cupola shop the iron which comes from the cupola has a relatively high sulphur content which may run up to 0.2 per cent. This may be reduced by adding soda ash to the iron in the ladle. The fluid slag which forms is removed and the metal then charged into the open hearth. Approximately 70 hours of operation is obtained before relining of the cupolas is necessary. Average yield runs from 94 to 97 per cent.

One cupola recently installed has such unusual features as water cooling of the bosh lining, increased blast pressure, a carbon paste well bottom and permanent bottom construction. This latter unit was designed for six months uninterrupted service between refractory repairs.

A good deal of work has also been done in the foundry industry on the use of oxygen in making steel. Oxygen has been used as additions in the cupola and experimental data report that with a 10 per cent oxygen addition and an 8:1 coke ratio, the melting rate is increased 20 per cent. Tapping temperature is about 100 F higher than with normal blast. By controlling the oxygen content and total volume of the blast, the tapping temperature and melting rate can be controlled to suit prevailing conditions. Oxygen contents of more than 10 per cent of the total blast require a low coke ratio and result

in high tapping temperatures. The addition of 8 to 9 per cent oxygen to the blast will give operating conditions and temperatures similar to that with a 5:1 coke ratio even though the iron to coke ratio is increased to as much as 12:1.

The increased service which furnaces must withstand because of the use of oxygen, compressed air, etc., has led to a great deal of study of refractory performance. At the present time the AISI is engaged in standardization of terms so as to be better able to evaluate performance.

Open hearths with basic ends are being more widely used. At the beginning of the year, 14 furnaces were in operation with suspended basic ends and installations for 14 more furnaces were planned. One plant found an increase of 5 to 7 per cent in production because of reduced repair time. Repair costs were correspondingly reduced from three to five cents per ingot ton. Also, because of the increased production, there is a reduction of fixed costs of about 5 cents per ton. These savings will pay for the heavy initial cost of installation in a period of two to three years of operation. Some operators have claimed savings of from 10-25 cents per ton of steel produced by their use. A number of problems must be overcome before they are universally adopted. With basic end furnaces there is high air infiltration because of the expansion allowances. If basic refractories are used for both ends and roofs, it is necessary to have a completely suspended structure, a minimum of projecting corners or ends, joints tight enough to prevent hot gas penetration or cold air infiltration, metal encased brick, and sufficient provision for expansion to prevent buckling.

The all-basic furnace at South Works of Carnegie-Illinois Steel Corp. has had rapid erosion and slag accumulation at the port ends and up-take area. This is contrary to the reports given by some of the other installations, and is believed to be due to the high firing rates and high temperatures used on this furnace.

Another steel plant reported during the year that their operating experience shows that basic end furnaces are operated at a lower repair cost per ton than the conventional silica end furnaces. Their experience covers a period of four years and after 13,800 heats operating costs of the two types of furnaces were comparable, and at the end of 42 months the basic furnace cost was 11 per cent under the silica end furnace. One other effect noticed was that the fuel consumption per ton of product was lower on the basic end furnace than conventional silica end furnaces, probably because reduced repair time cuts the loss of stored-up heat.

A good deal of work was done on refractories during the year, particularly in an attempt to develop one which would better withstand the effect of the use of oxygen in combustion. This work has also resulted in further knowledge on the action of refractory disintegration. One new type of behavior studied by laboratory experiments has shown that the repeated alternate oxidizing and reducing conditions at 2200 and 2400 F causes a spongy growth in the iron oxide. This growth apparently occurs because of the conversion of one oxide to the other.

One super-duty silica brick which is now finding its way into installations has a maximum content of 0.5 per cent alumina, titania, and alkalis as compared with the



usual 0.9 to 1.4 per cent for the conventional silica brick. This slight difference in content, however, makes an appreciable difference in the resistance of the brick. There was a good deal of demand for premium priced super-duty silica brick during the year.

Some steel plants because of the good results obtained with the carbon hearth in blast furnaces, are considering carbon blocks to replace chrome brick below the rammed or burned hearth in the open hearth furnace.

Production of steel in bessemer converters, which for many years has been the second largest producer of steel, fell back to third place for the first time as electric furnace production overtook bessemer production. The side-blow converter, however, may offer an opportunity for bessemer production to attain second place again. At the present time a large steel company is experimenting with a 22-ton vessel. The operation of a side-blown unit is similar to that of a standard unit except that 15 to 20 minutes blowing time is needed instead of 10 to 12 minutes and the contact between the blast and metal is on the surface of the bath. As a result of the longer blowing time, there is better control of the blowing operation. The quality of the steel is better than that of ordinary bessemer steel and the initial cost is less than a standard bessemer of the same capacity. Blast pressure for the side blow unit is approximately one-fifth that of conventional converters or 4 to 5 psi.

A great deal of test work has already been done on side blown converters in foundries in England and oxygen was used in the blow. These tests showed that a moderate enrichment of the blast reduced blowing time by one-half. This factor is not, however, important in foundries but may be important if this type of unit is used in production of steel plates. Another conclusion reached in the test program is that the quality of the product made with oxygen enriched blast is in no way inferior to that produced without the use of oxygen, and carbon contents were more consistent. As far as could be ascertained the oxygen had no bad effect on refractory life. High temperatures were obtained by its use.

Other work on the use of oxygen in converters was reported last year by V. V. Konjakov on the results of a special converter plant which was built at the Kuznetsk steel works in Russia. Oxygen in concentrations of 50, 75 and 100 per cent was used. Results showed that oxygen blast could be applied to metal with a low silicon content, although further improvement is necessary in the reduction of phosphorus. Increased mechanical strength was obtained and the nitrogen content was very low. Oxygen consumption was about 1410 cu ft per ton of charge. The process needs further development in order to obtain longer service of the tuyeres.

Additional information was also obtained during the year on work done by the Germans. The so-called Maxhuetten plant in Oberfalz, Bavaria, is so located that there is a great deal of scrap available. They therefore installed an oxygen plant to supply five converters, four of twelve-ton capacity and one of fifteen-ton capacity. The average converter life was about 150 heats, and that of the bottom was 45 to 50 heats. Their work indicated that most suitable concentration was 30 per cent oxygen. Greater concentration produced neither hotter nor a shorter blowing time. The procedure gave

them high temperature and made it possible to add and melt 12 per cent more cold scrap. Large pieces of scrap as high as three tons were melted successfully in a ten-ton converter. In such cases, although a portion of the ingot was not melted at the time of the end of the first blow, it would be dissolved when the pig iron was added for the next blow. The process also allowed the use of pig iron with relative low contents of phosphorus. Cost savings were appreciable, although for other installations this will depend on the relative cost of scrap and pig iron. The operators estimate that one kilogram of scrap could replace one kilogram of pig iron for every cubic meter of nitrogen which was eliminated from the blast. Because of the reduced blowing time it was possible to melt four heats per hour instead of three. The yield was increased to 87 to 88 per cent of the charge compared with 86 per cent yield without oxygen. Quality was improved and it was possible to manufacture deep drawing high silicon steels for dynamo and transformer sheets, apparently because of the low nitrogen content.

Experimental oxygen was used on a test program at one American bessemer converter where the metal was blown down to approximately 1.7 per cent carbon. The oxygen had a purity of 99½ per cent and a maximum oxygen content of 24.7 per cent was used in the converter. Twenty per cent more scrap than normal was charged and blowing time was reduced from 10 to 7 minutes. Production was 37.5 per cent greater in terms of tons of blown metal produced per minute and this performance was reached with 258 cu ft of oxygen per ton. In another series of tests at the same plant, oxygen was turned on at the start of the blow at a rate of 1000 cfm for three to four minutes until the scrap was melted and after the carbon blow the oxygen was again turned on for one or two minutes at a rate of 800 cfm in order to obtain a final silicon reduction. Results of this practice gave a good quality of blown metal with a clean hot iron and a very good slag separation. Silicon was reduced from a normal of 0.10 to 0.006 per cent. Blow

The main roof on number 16 furnace at the Steel Company of Canada is a radially suspended basic roof.

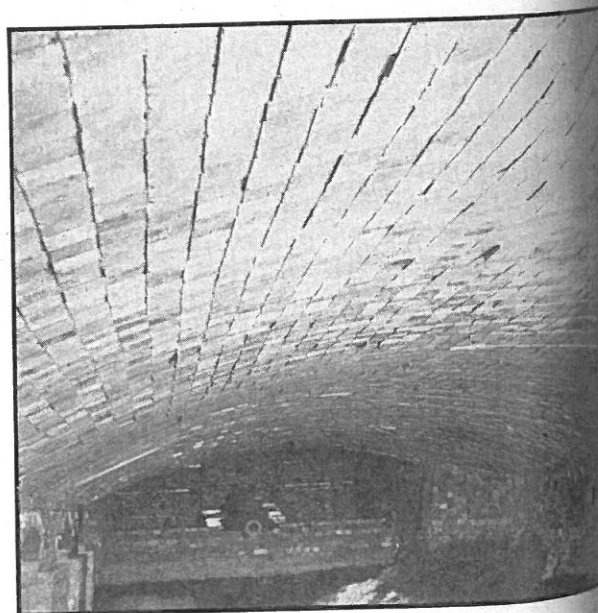

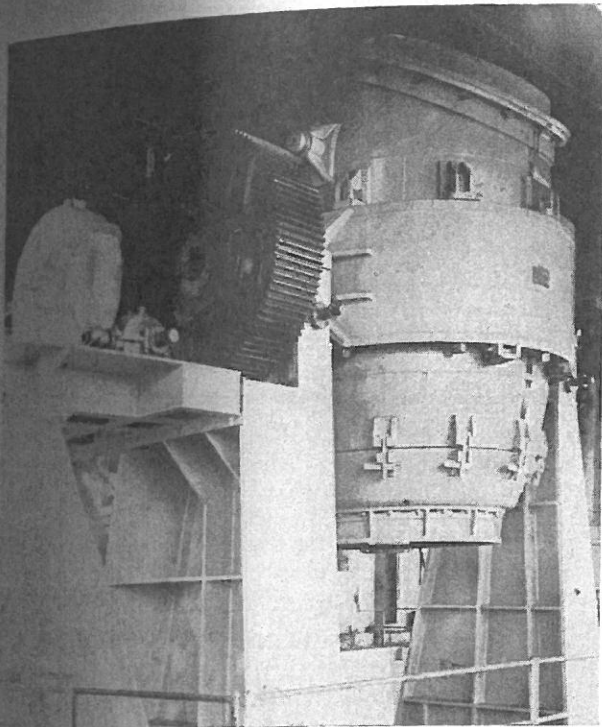

This new bessemer converter uses a maximum amount of welding in its construction. It is a 30-ton unit.

ing time was reduced from 9 to 6.34 minutes for a decrease of 29.5 per cent, and production was increased 40 per cent, or from 3.00 to 4.33 tons per minute. Oxygen consumption was 216 cu ft per ton. At this steel plant an oxygen plant with a capacity of 400 tons per day of 93 to 95 per cent pure oxygen is being constructed. The products of this plant will be piped so that they can be supplied to intakes of four turboblowers supplying cold blast to three 1200-ton blast furnaces, and also to a 400,000 cu ft storage bank. This in turn will supply oxygen to open hearth furnaces and to bessemer converters.

A new thirty-ton bessemer converter installed during the year is of welded plate construction. A minimum number of castings are used and in the case of the trunnion ring the trunnions are castings which are welded to the plate ring. Anti-friction bearings are used throughout with the exception of the trunnion ring bearings which are bronze bushed. Instead of cast teeth, the drive gearing has cut teeth.

Electric furnaces were the second highest producer of steel for the first time, principally because the shortage in open hearth steel led to the production of open hearth grades in the electric furnace. Also, alloy steel production for 1948 will probably exceed that of 1947 by 1,000,000 tons. The so-called triple alloy steels which contain nickel, chromium, and molybdenum were produced in greater tonnages than any other classes of alloy steels.

Some authorities feel that the large electric furnace may be highly competitive with the open hearth as a means of finishing hot, partially decarburized iron from the converter. This is because the electric furnace, for the same grade of production, is usually more economical than the open hearth except for power and electrode costs which in turn are largely dependent on the energy required for meltdown of the scrap charge. A

liquid charge, close to temperature, cuts power and electrode costs down to a point where the electric furnace becomes competitive. One of the most important advantages of the electric furnace over the open hearth in high tonnage operation is the higher temperature, which makes it possible to melt scrap at almost any desired speed, and to heat it several hundred degrees hotter than the usual working temperature in the open hearth.

It may be said that the so-called 70-ton furnace is the standard large unit today. This furnace has on the average a 20-ft inside diameter on the shell, has a flat bottom, and is mounted on rockers. It will have a holding capacity of about 175,000 lb. These furnaces use either a 12,500 or 15,000 kva transformer equipped with a wide range of secondary voltage controlled by a multiple position tap changer.

A number of additional furnaces were installed during the past year or are scheduled for completion during the first part of 1949. At one plant these facilities included two 70-ton electric melting furnaces as well as one 60-ton melting furnace. The furnaces on order will be able to turn out about 600,000 tons of steel annually, and when they are all installed at the end of 1949, electric furnace capacity will be increased about 12 per cent. Most of these furnaces are scheduled for high carbon steel production. In 1948 approximately 60 per cent of the steel produced in the electric furnace was carbon steel.

Oxygen instead of iron ore for an oxidizing agent is becoming standard practice in making electric steel. The oxygen is used in the electric furnace to perform three functions: remove carbon, control bath temperature, and melt scrap. In one method the oxygen is introduced slightly below the slag metal interface by an iron pipe lance. In another method, a water cooled non-consumable tool is used to direct the oxygen through the slag into the metal. Experience in the electric melt shop shows that the use of oxygen increases tons per operating hour, improves alloy steel quality, and results in cost savings which are most apparent in manufacturing stainless steel. The cost saving in this latter case is largely due to the larger quantities of stainless steel scrap which can be charged. There is also an improved recovery of chromium from the stainless scrap.

Methods of improving yield have continued to receive considerable attention. An installation of electric hot tops was made in a plant devoted principally to specialty steels. On 9 in. sq ingots the method has given yields ranging from 92 to 96 per cent. In the process, heat is applied to the top of the metal teemed in an ingot mold while the teemed metal is covered by a protecting blanket of flux. The heat is supplied at such a rate that a reservoir of highly heated molten metal of gradually diminishing size is available to feed to the solidifying metal underneath as volume change takes place. An installation consists of a source of power and a liquid-cooled, non-consumable, non-contaminating electrode.

Other procedures receiving some attention are a mold-shaker and a punching and upsetting operation. In the former, the mechanism is mounted on a narrow gage track, and jolts the mold at a frequency of 24 to 50 times per minute until the ingot is about 75 per cent



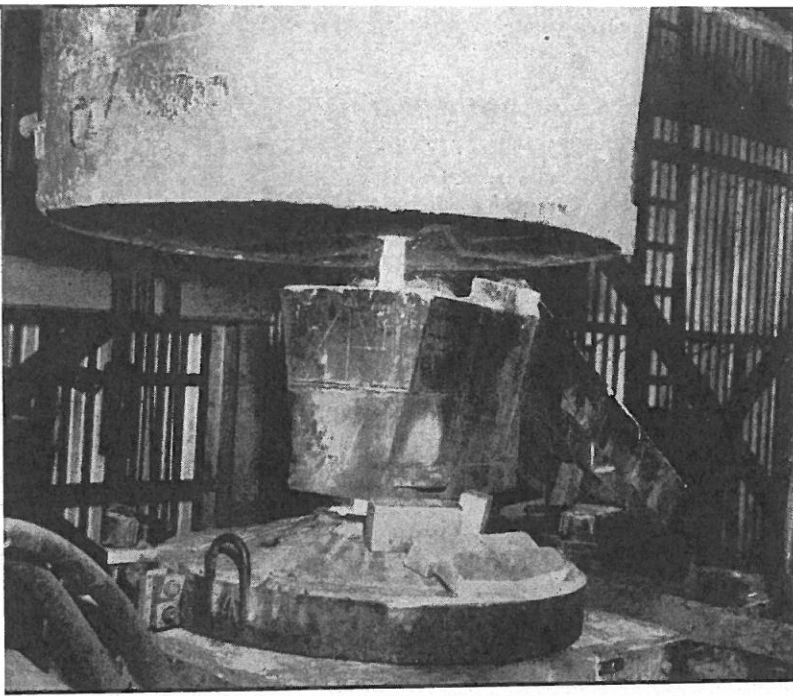

In the first step of the continuous casting process molten metal is poured from the transfer ladle into an induction furnace from which it will be poured into a tundish which is designed to strain out the slag.

solidified. An increase of about 2 per cent in yield from rimmed steel ingots is claimed. In the latter process, the steel is poured into big-end-up molds with a taper several times that normally used on hot top ingots. The ingot is then placed in a cast iron holding die and a hollow tapered punch is driven into the top of the ingot and into the segregate. In the next step, the steel surrounding the segregate is driven down past the bottom of the segregate, and in the last step the ingot is removed from the holding die and forged to a size suitable for the blooming mill. With a scale loss of 3 to 4 per cent, a bottom crop of 2 to 3 per cent, and top crop of 14 to 5 per cent, a blooming mill yield of about 90 per cent can be obtained.

Continuous casting caused a great deal of furore in the past year, and the method is being used experimentally at a steel plant producing billets for seamless tubing. As now operated, the casting unit casts two or three times a week. The casts are both alloy and carbon steel. The equipment is housed in a vertical 75 ft tower. Molten steel is carried to the top of the tower by means of transfer ladles, which are then emptied into an electric induction ladle. The steel then passes into a tundish and then into a water cooled mold. The billet which is now chilled, goes down through an insulating sleeve at a speed controlled by pinch rolls. An automatic acetylene torch cuts the billet to desired lengths which are lowered to a horizontal position. Experience has shown that the faster the casting rate, the better the resulting surface. However, the metal must be brought in contact with the mold when the metal is at optimum viscosity.

The method offers possibilities for the production of small billets which can be used directly for rolling some products, and may eliminate in such cases the use of ingot pouring facilities and soaking pits as well as the blooming mill. The method is still experimental, however, and much work must still be done before the process becomes a commercial procedure.

A method for making small ingots of high grade specialty steels uses an electric arc for melting the various materials under a slag blanket. The ingot may be of any desired size or analysis, and is produced by progressive solidification as alloying elements are fed at a controlled rate directly into the mold from which air is excluded. A tube is formed from cold rolled strip which becomes a consumable electrode and is melted in the mold by the arc. Inside the tube a smaller tube conducts alloy elements to the arc where they are liquified and distributed in the bath. The ingot or billet is produced in a copper water cooled shell. Solidification starts at the bottom and as the ingot grows the mold is pulled down so that the arc stays at the same spot. Melting speed for a single ingot machine is about 7 lb per minute. Ingots now being produced are 6 ft long with 11 in. maximum or 4 in. minimum dimensions. This method should not be confused with the electric hot top process.

## ROLLING

A number of plants are increasing cold rolling capacity because the demand for such products continues strong and by the end of 1948 the steel industry was able to make 21,000,000 tons of sheet and strip, an all-time high.

The trend to faster rolling mills increased and five stand tandem tin-plate mills having maximum speeds over 4000 fpm were installed during the year. One five-stand tandem cold strip mill has a top speed of about 6000 fpm or 70 mphr. This particular mill is driven by twin motor drives, but with no idler pinion connecting the top and bottom roll. Synchronization is accomplished entirely through electrical control.

This mill has 16,500 nominal hp in the drive motors. There are two 10,000 hp motor generator sets, each with three generators. The mill will roll strip up to 36 in. wide and will finish to gages of 0.008 in. and less from strip up to 0.109 in. thick. When rolling at 6000 fpm, a 15-lb coil can be rolled into tin plate in about five minutes.

The control system used in the mill is an improvement of the rotating regulator which was used in the gunnery control system of the B-29 bombers. The regulator maintains the proper speed relationship between the various mill motors. By means of the control the mill can be accelerated from 300 fpm to 4500 fpm in six seconds.

This mill is the first tandem mill to have individual roll drives on the last three-stands and the first mill to have rotating regulator controlled screwdowns. The screwdowns have the fastest response and speed of operation of any tandem mill. A separate generator for each stand increases the flexibility of operation. Generator voltage control is used as well as modern field control to adjust between mill stands. It is also the first mill on which X-ray equipment has been regularly used for finish gage.

A new development in rolling mills is a 4-high reversing cold strip mill in which the back-up rolls are driven with the strip under relatively high tension. The results of the operation of a small 10 in. pilot mill show that reductions can be made on 18.8 stainless, 3.5 per cent

high melting ingot produced from rolled steel is melted in a tube are liquid. Billet is solidified in the mill same as about 6 ft. nsions. Electric hot

Si and 1.25 per cent C steels which approach those considered normal for low carbon steel on the present conventional 4-high mill. Trial reductions of up to 59 per cent were made without slippage between the rolls. Production is said to be three to ten times that of a similar size mill of the all-pull type when rolling the thinner gages. High silicon steel has been rolled from 0.025 to 0.010 in. and low carbon steel from 0.020 to 0.006 in. three passes. A larger mill of this type is now under construction.

Temper mills are also becoming faster and at the present time a 42 in. 2-stand mill is being built for 5000 rpm. This mill incorporates all the latest features in electrical equipment and nearly matches the output speed of the fastest tandem cold reduction mills.

A number of new continuous pipe mills are now under construction. One new mill which is being built in the Chicago district will make pipe up to 4½ in. outside diameter and will be capable of producing from 120,000 to 150,000 net tons of product per year.

What constitutes a modern seamless tube mill will depend on the size ranges of the products. In a plant making small tubes up to 5 in., a combination of the rotary billet heating furnace, a combination cone-type Mannesmann piercing unit, a continuous rolling mill with an Assel mill as alternate, and a universal stretch-reducing and sizing mill with perhaps a cross-roll sizing mill for heavy walled tubes will constitute the mill

setup. For tubes from 6 to 16 in. in outside diameter, a combination of a rotary furnace, cone-type Mannesmann piercer, a two-high plug rolling mill, two reeling machines and a series of two-roll sizing mill stands will be used. For pipe from 16 to 26 in. outside diameter, a modern combination consists of at least two large rotary heating units, two Mannesmann or cone-type piercing mills, a plug rolling unit, a rotary expanding mill, two reelers and a series of two-roll sizing units. From present indications, tubes will, in the future, be made much faster and piercing speeds will be increased. Inside surfaces will also be improved.

Recent experiments indicate that high alloy tubing will probably be made by extrusion. Carbon steel tubes can be extruded in sizes as small as 2 in. outside diameter with minimum wall thicknesses of 0.079 in. in lengths up to 50 ft, and stainless steel tubes can be made in diameters as small as 3 in. with minimum wall thicknesses of 0.117 in., in lengths up to 30 ft. Since the operating crew can be as small as 4 or 5 men, and the investment is less than that of the modern piercing mill, the process has potentialities, particularly when it is considered that alloys which cannot be pierced can be processed by this method.

A 4000-ton extrusion press which was used during the war for the production of rotating shell bands is now producing pipe in nickel, monel and other high nickel alloys in diameters up to 9¼ in. and in lengths up to 12

Cutaway sketch of 5-stand, 42 in. tandem cold strip mill shows mill proper, motor room and basement.

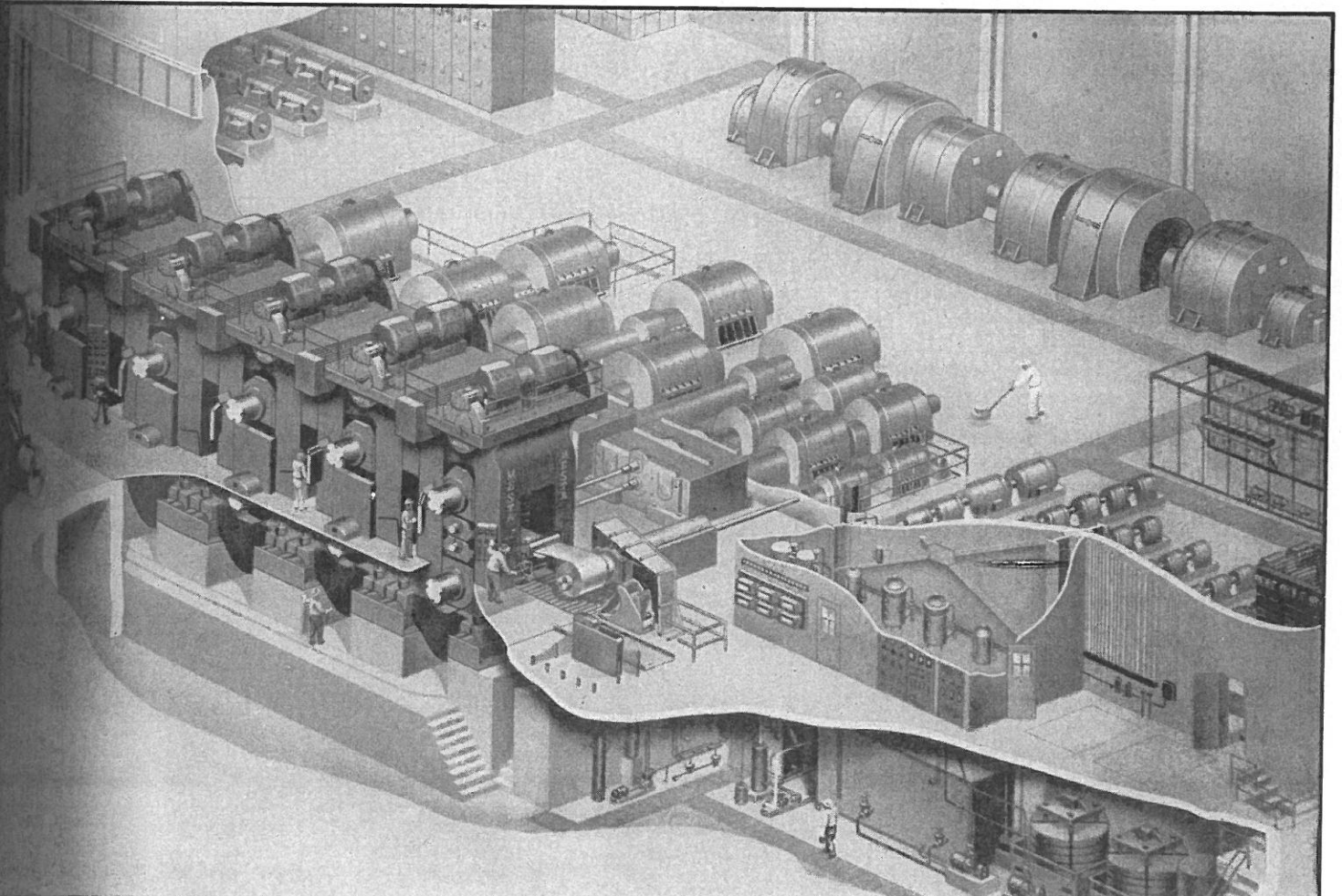



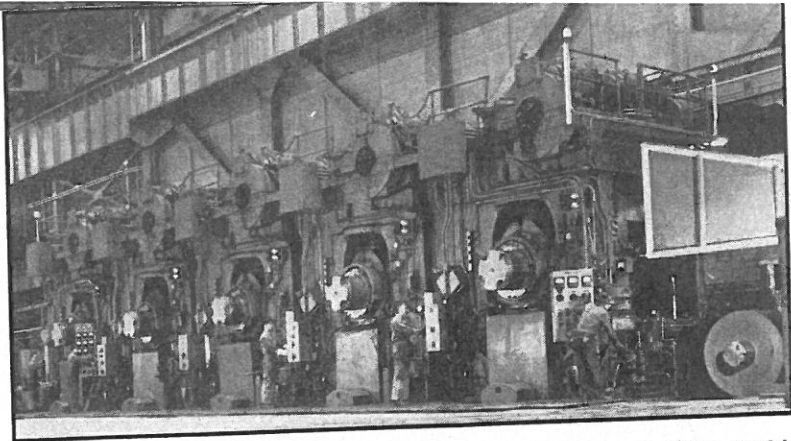

The finished coils of the 70-mph mill have a 16 in. inside diameter and the outside diameter ranges up to 66 in. maximum. The finished coils weigh up to 30,000 lb.

ft. These shapes can be cold drawn into seamless pipe 8 in. in diameter, and with wall thickness up to  $\frac{3}{4}$  in.

An innovation in welded tube mills is a twin-seam mill developed on the west coast. The first operation in this mill is to seam weld the edges of the strip, which is fed above and below the mandrel, with two resistance seam welders which are mounted face to face on wheeled carriages and operate along the track. The strip which is welded while flat is then moved over the mandrel by means of driving wheels and the mandrel forces the tube from a flattened oval to a true diameter in a distance of about 6 ft. A brass mandrel is used in order to cut down friction. This method makes possible wall thickness ratios of less than  $\frac{1}{250}$  of the tube diameter in comparison with ratio of  $\frac{1}{60}$  with the normal process. Tubing is processed from 20 to 24 gage strip at a rate of 50 fpm. Changeovers can be made from one diameter to another in about an hour.

A new style round straightener for bars and tubes was introduced during the year. This is a seven-roll machine which has clusters of three rolls at the entry and leaving ends of the machine, and a pressure roll in the middle. The rolls are mounted at an angle to the pass so that the stock rotates as it passes through the machine. The three-roll group confines the material to its exact pass line and there is no tendency for the stock to find a path of least resistance and thus evade the

In a new 4-stand cold reduction mill which had twin motor drives, the work rolls of stands 3 and 4 are driven through a speed reducer and speed increaser respectively but the gear ratios were made the same in both cases thus enabling the use of duplicate equipment.

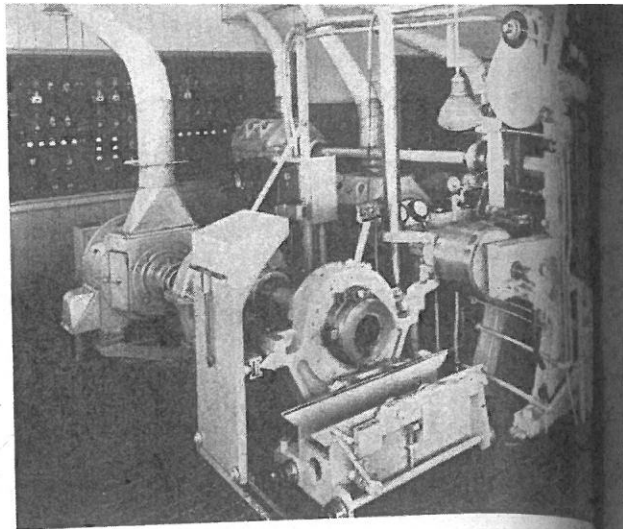
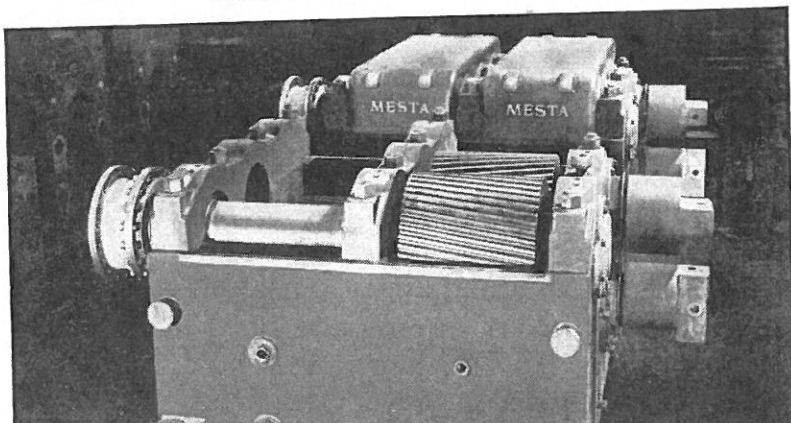

A pilot 10 in. reversing cold strip mill, driven through back-up rolls, was built during the year.

middle roll. No guides are necessary and the material comes in contact with rolling surface only.

About 8 per cent of the steel made in this country wire and more than half of this is used in the midwest. The large constant demand for wire products has resulted in many improved operating practices. Present practice, carbide dies have replaced steel and cast iron die plates almost completely, resulting in a three-fold increase in drawing speeds which are more than 1500 fpm for ferrous materials. Present drawing practice use reductions up to 38 per cent on most carbon steel, and from 25 to 30 per cent on high carbon or spring wire. In drawing high carbon wire water-cooled dies and blocks are used in order to dissipate the heat in the drawing operation. Such cooling is essential if the highest quality wire is to be finished at the indicated speeds, and particularly if close tolerances are required.

Because wet drawing of high carbon wire demands extreme care and rust-free material in order to obtain high production and in order to protect the dies, a compound of amorphous metaphosphate has been used to inhibit rust and lubricate the wire in process.

A new two-stand temper mill is driven by a 500-hp motor on No. 1 stand and an 800-hp motor on the No. 2 stand. Work rolls are 18 in. in diameter and back-up rolls are 49 in. in diameter. Machine finishing speed is 3000 fpm.

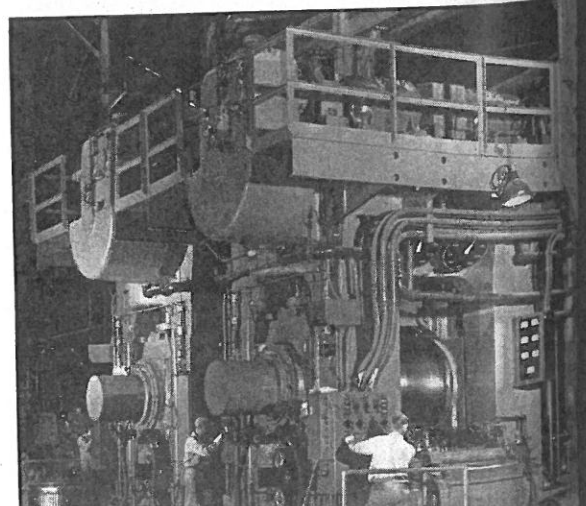



...that the use of this compound has allowed an increase of drawing speed up to 25 per cent. It has also effected a sharp reduction in damage to dies and wire. The amount of lime which is subsequently picked up is as critical as in conventional practice.

A new flying shear was built during the year with a drive consisting of a single motor directly connected to the bottom knife of the flying shear. The knife is controlled by an adjustable voltage d-c generator driven by a synchronous motor, and a combination rotating controller and electronic control. The shear can be operated to the proper speed in about 3/4 of a second and can be stopped in the same period.

### FINISHING

A new continuous galvanizing line, believed to be the first continuous line to use high frequency induction

takes much less time. At the same plant, a similar type line for light gage sheets is under construction.

Electrolytic tin plating of strip steel is being done at ever increasing rates and 38 in. wide strip has been plated with 0.03 mil of tin at a speed of 1000 fpm. A current density of 225 amps per sq ft in an alkaline stanate bath was used. Several electrolytic lines for the production of tin plate have reached maximum speeds of 1330 fpm and even higher speeds appear probable.

An effective method for continuous reflowing of tin uses gas radiant heaters for the heat source. The method gives heat at high rates for fast electrolytic tinning line speeds and the amount of heat can be easily controlled because of the inverse square law for radiation effect. The amount of heat can be easily and quickly controlled. A uniformly bright coating is obtained at economical costs. Another favorable factor is low space requirements.

An attempt to reduce the heavy manual labor job inherent in the manufacturing of tin plate, a set-up has

mill, driven  
ing the year.

...cessary and the surface only. ... made in this is is used in ... d for wire pro ... l operating p ... have replace ... mpletely, res ... speeds whic ... materials. P ... is up to 38 p ... i to 30 per ce ... wing high ca ... e used in ord ... peration. Suc ... wire is to be ... ularly if close

...h carbon wire ... erial in order ... protect the d ... phosphate has b ... wire in pro

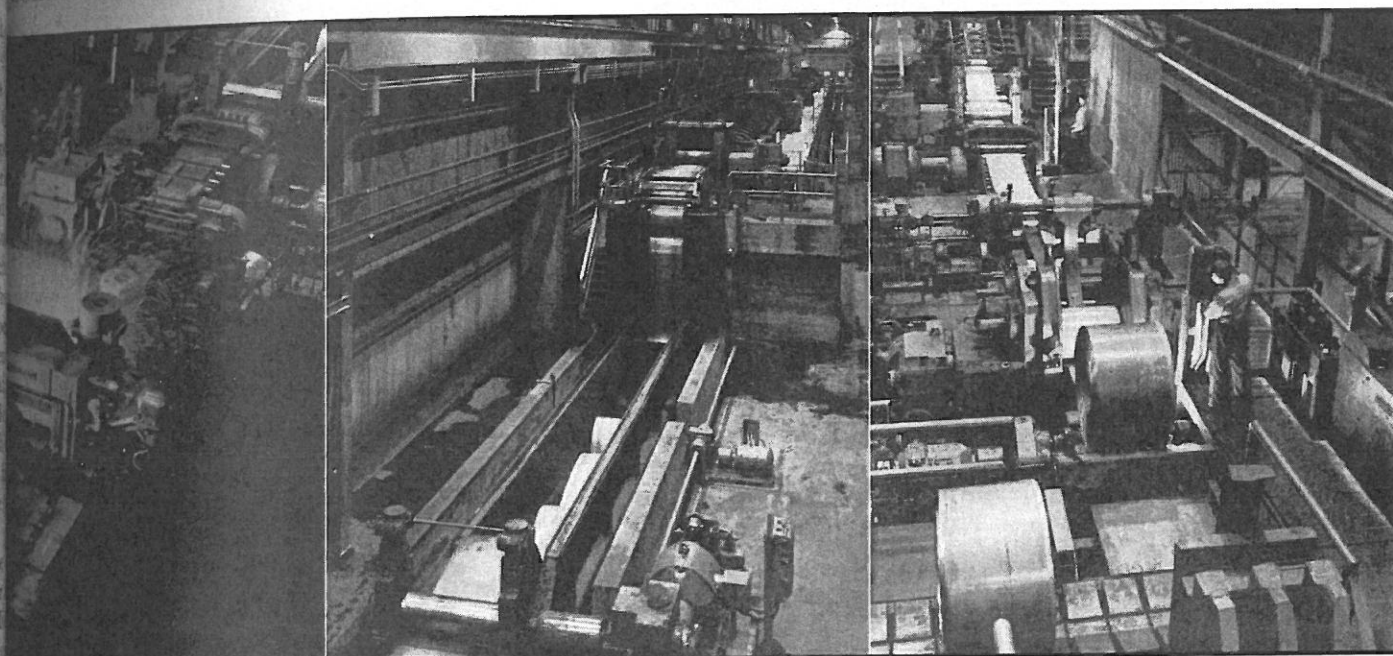

A new continuous pickle line was installed to serve the 70-mphr mill and on the left is shown the welding machine which welds into a continuous strip the hot rolled steel before it enters the pickle tanks. In the center the steel strip is shown coming out of the looping pit. Strip goes through four pickling tanks each 80 ft long. On the right the strip is emerging from the rinse tank from which it goes through a drying unit to eliminate wet patches on the strip before it is coiled.

...driven by a 600 ... motor on the ... ter and back ... nishing speed

...ing and to process continuously from the unannealed-reduced coil to the finished galvanized sheet has been announced. This line has been in operation for some time but details have been kept secret. Other similar lines are believed to be in use, although such have not been announced. The equipment coats coils from 20 to 54 in. wide and from 11 to 18 gage. In a four run, production will average 300 tons and the speed varies from 8 to 120 fpm. The units in the line consist of a leveler, automatic welder, electrolytic cleaning pit, furnace, galvanizing pot, cooling tower, pickling tanks, bonderizer, looping pit, leveler and shear. In the furnace the sheet is first heated by induction heating and this is then followed by resistance heating. A hydrogen-nitrogen atmosphere is used for heating and cooling. It is reported that the coating is more uniform, there is some saving in zinc, and the operation

...been installed in a plant in which lifts of sheared plate weighing up to 10,000 lb are delivered directly from the flying shears to the entry end of the tin stacks. These are then fed through a two-pass feeder into an electrolytic pickling tank consisting of a rubber lined tank equipped with two conductor roll assemblies in which the top roll of steel or carbon is paired with a bottom roll of rubber with glass micarta finger guides set between the conductor rolls. This automatic feeding and electrolytic pickling of sheets has eliminated the former white pickling operation as a process in tin manufacturing. A continuous line was also set up in tandem with a tin machine to inspect, count, weigh and package the material. The sheets go by conveyors to an inspection wheel where an inspector checks the sheet and by push button control sends them into three pilers, prime piler, mender piler and waste piler.





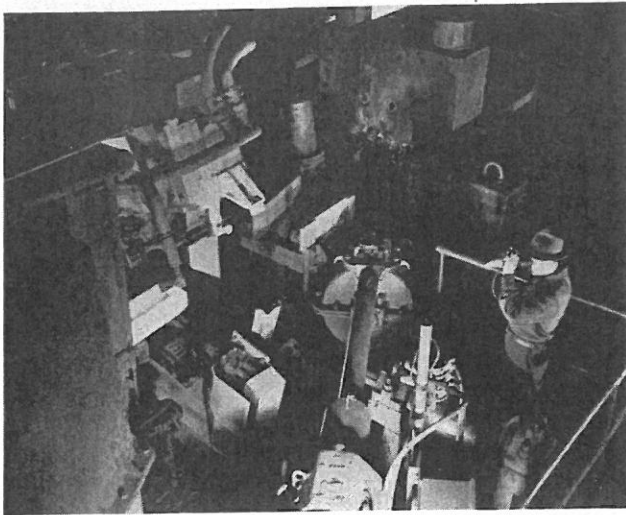

The first fully automatic flame scarfing machine for removing surface defects from steel blooms was installed during 1948.

A new process of plating was developed in the past year which can be used for continuous plating of strip moving at fairly high speeds. Heat is the sole means for deposition in this new gas plating process. The process depends on thermal decomposition of metal carbonyls in an inert atmosphere of carbon dioxide. The object to be plated is heated by radiation in a plating chamber which is supplied by a metal carbonyl generator. A closed system is used which recycles the plating gases for operational economy. Carbonyls of a number of metals, including nickel, iron, chromium, tungsten and molybdenum, may be used in the process. Surface preparation is the same as for electrolytic plating. In a laboratory test operation using a small experimental unit, over 13 lb of nickel was deposited in a 60 minute single pass plating cycle. In another operation on continuous strip, an amount of metal which would have required thirty minutes to apply by conventional methods was deposited in four seconds.

A new method of plating wire has been developed which differs from normal procedures in that the desired plating metal is deposited on a heavy gage base wire by electrolysis in such a way that it will not sepa-

rate from the base material and the wire is then further processed to the desired size and temper.

A unique feature of a new pickling line is the absence of the conventional dancer roll in the pickling tank. Replacing this roll, which has always required a great deal of maintenance, is a magnetic loop-position regulator which consists of a magnetic detector unit encased in an acid proof cover and located in the bottom of an acid filled tank. The output signal, which is governed by the position of the steel strip in the tank, is fed into a magnetic amplifier which in turn controls the speed of the entry pinch roll through a booster generator.

Some plants have found that steam jet agitators in pickle tanks give much faster and more economical pickling if the steam lines are installed so that the nozzles are set on about 15 in. centers. Practically every foot of the pickling line is thus heated and kept at optimum temperature.

Investigation of the formation of scale has shown that the scale formed on low carbon steel at temperatures above 1065 F consists of three layers which from the outer surface in towards the center are  $Fe_2O_3$ ,  $Fe_3O_4$  and  $FeO$ . Because of these layers, some operators recommend that oxide conditioning of strip should be as follows: strip which is hot finished at 1300 F should be quenched on the runout table to 700 or 750 F before entering the coiler and this is specified for coil running from two to four tons whose heat-back upon coiling will elevate the temperature from 900 to 950 F. Following an air cool to 700 F, the coil should be water quenched and then they are ready for pickling.

A southern mill is using synthetic detergent which when introduced in the pickling baths, reduces pickling time 30 per cent for hot rolled steel. The detergent has a wetting action which reduces drag out and improves pickling efficiency, while the foam on the bath surface blankets gassing and fuming.

Electrolytic polishing of stainless steels is developing at a rapid rate. The method produces a highly lustrous mirror bright finish. The operation is similar to electrolytic plating except that current flow is reversed and the work is done on the anode. The process primarily supplements rather than replaces mechanical polishing. The equipment is simple, necessitating only a process

One of fourteen mechanical assorting, piling and reckoning lines installed this year in a West Coast mill for hot tin plate. The sheets proceed by conveyor to the inspection wheel where the operators inspect both sides as the wheel automatically turns over the sheet. By pressing a button the inspector can pass sheets to two piles for prime grade material or allow it to travel to the end of the line where prime plate is piled.

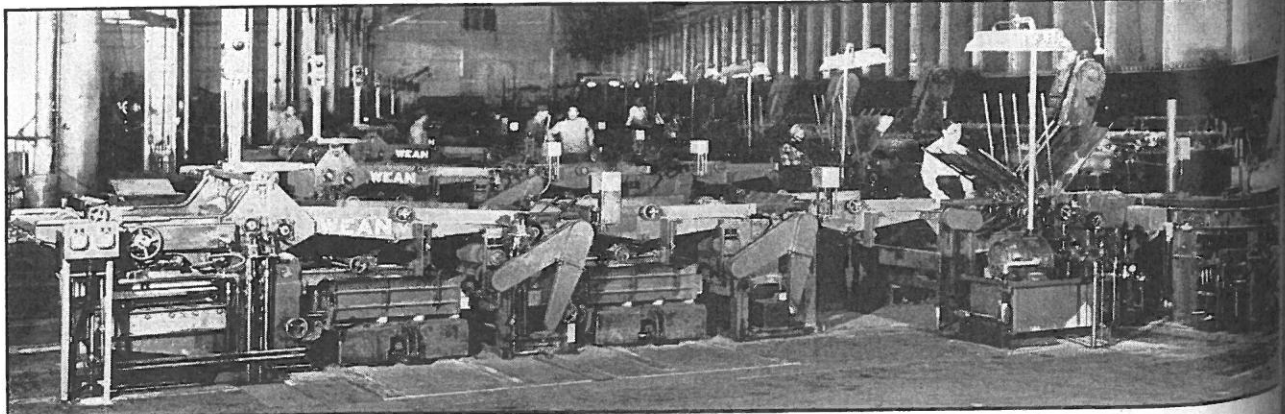

ing solution tank with a suitable arrangement of anodes and cathodes, a power source and rinse tanks. Current density runs from 0.5 to 1.5 amp at approximately 6 to 8 volts.

Molten salt baths are being used more and more for descaling. The fused salts change the scale chemically and thus its removal takes only from 0.1 to 0.01 of the usual pickling time. In one process, which has 38 units installed in 31 plants, the material to be pickled is dipped in a molten bath of a mixture of salts, and then passes through a water quench, acid quench and finally a rinse. Temperatures of from 900 to 1000 F are used and the baths are heated either by external gas firing, by immersion tubes or by immersion electrodes. The salts consist of a mixture of alkali, metal hydroxides, oxidizing agents and certain catalysts. The combination is such that they ordinarily regenerate themselves, for when the oxidizing agents have been reduced by the reaction with the scale they are reoxidized by the atmospheric oxygen at the surface of the bath. The process is very versatile and can be used on chrome-nickel and straight chrome stainless, stainless clad, and carbon steels, as well as on nickel and many types of alloys.

The sodium hydride process is similar to that described in the previous paragraph, but operates at a lower temperature (700 F) and the chemical reaction is better understood. Several sodium hydroxide descaling plants went into operation, and were found particularly effective in removing the metallic oxide scale on stainless and clad metals. Briefly, the process consists of immersing the material to be descaled in a molten caustic bath which has been impregnated with sodium hydride, the caustic bath provides the wetting action and carrying body for the sodium hydroxide which has a great affinity for the oxide scale. The stainless material is then dipped into a water quench tank where the reaction blasts the scale free. This is then followed by a dip into 10 per cent sulphuric acid for neutralization of the caustic and then by a dip into a nitric-hydrofluoric acid bath for brightening, after which the material is cleaned with water.

Shot blast cleaning is also finding additional applications. Although it cannot eliminate acid pickling, it can be used efficiently when the coating to be removed is hard and dry, and in the steel plant its particular application is for cleaning preliminary to electro-plating, galvanizing, hot dipped coating and metallizing. The cleaning must be done with a fine grit. Another application is for cleaning strip or sheet before cold rolling, although in this case it is sometimes desirable to follow up with a brief 20 to 30 second pickle to remove iron dust. The blast cleaning unit can be adapted to either batch or continuous operation. It has the advantages of no waste disposal problem, and requires less floor space. There is no danger of hydrogen embrittlement, and there is no appreciable metal loss in proper operation.

The disposal of waste pickle liquors is receiving considerable attention. Because of the increasing scarcity of high-calcium lime to be used as an acid neutralizer attempts are being made to find substitutes, and readily available dolomitic limes have been found to be adequate, although they have lower reaction rates with acids. The basicity advantage places the two agents on a relatively equal basis.

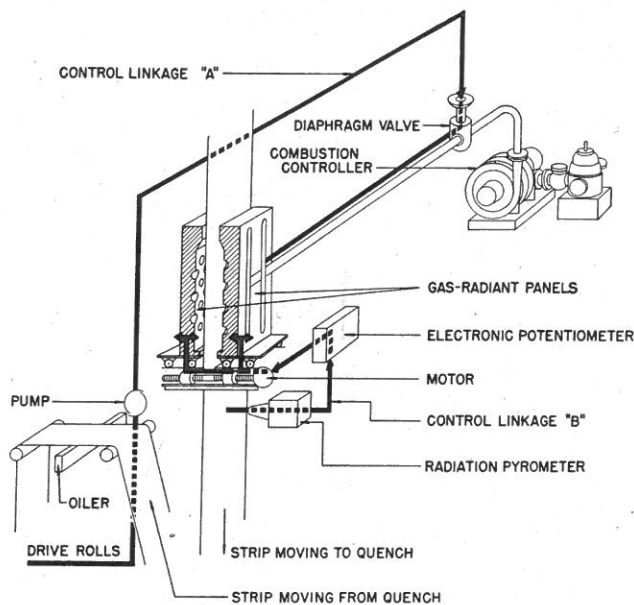

**Extremely rapid temperature control is available for reflowing of tin by the gas radiant method. Two control systems are actually used, "A" has the function of throttling fuel input to the heating panels in proportion to the line speed. Control system "B" has the function of moving the radiant panels to and from the passing strip. These movements are made in direct response to strip temperature as it is measured by radiation pyrometer.**

In a series of studies on absorption methods for handling waste pickle liquor at the University of New Hampshire, the best selective absorption for ferrous sulphate, in neutral and acid solutions, requires use of activated charcoal. Ninety per cent of the ferrous sulphate in neutral and acid solution was found to be absorbed by the equivalent of activated charcoal.

## FUELS AND FURNACES

One important factor influencing combustion is the ever changing fuel picture. From a long range point of view, because of the ever increasing demands for petroleum as well as the continually rising cost of locating and producing crude oil, it is believed that the price of petroleum will establish itself at such a level that the deliberate diversion of crude oil to fuel will be uneconomical. It will then become necessary for other fuels, and coal in particular, to assume an increasing proportion of the industrial fuel load.

Since liquid fuel can be produced synthetically from such raw materials as coal and natural gas, these processes will undoubtedly come into production as crude oil becomes sufficiently scarce. Various methods for doing this are being tried at the present time. It is more costly to synthesize liquid fuel from coal than from gas, but because of the greater reserves of coal, this method will in the future probably be the most important. About 6500 tons of coal with a Btu content of 12,000 to 13,000 per lb are required to produce 10,000 barrels of petroleum.

Although the western hemisphere at the present time



has a surplus of oil production, it is estimated that by 1951-52 it will be necessary to import oil to meet our overall requirements. Importation is by far the cheaper method of getting additional fuels on present cost basis, but in time of war may not be a sure source of supply.

Secretary of Interior Krug has been pushing a program which would set up a synthetic fuels industry. He reports that the oil-shale demonstration plant at Rifle, Colo., indicates that crude shale oil can be obtained at \$2.00 and \$2.50 per bbl. He also estimates that the coal oil plant at Louisiana, Mo., can make high grade motor gasoline commercially for about 14 cents a gal which is about double the present cost. In the steel industry the shortage in oil has resulted in a trend since the end of the war from oil to coal or to fuels produced from coal. Blast furnace gas is being used to underfire coke oven batteries and in soaking pits. The coke oven gas thus liberated is being used in open hearth furnaces up to about a 50 per cent of the total heat input without a loss in steel production. Boilers are being fired with powdered coal or with coke breeze to replace blast furnace gas. If fuel oil is to be ultimately replaced entirely by coal, the next step would be to increase the use of coke oven gas in the open hearth, supplementing this with manufactured gas up to about 70 per cent of the total open hearth requirements, and filling out by 30 per cent firing of tar or pitch for luminosity and flame radiation requirements.

Two basic processes for converting coal to oil are under study at the new Bruceton laboratory of the Bureau of Mines. One is the gas synthesis or indirect Fischer-Tropsch process and the other is a direct hydrogenation of coal or Bergius process. These processes are complementary rather than competitive, for the products which each process will best produce differ.

The Bureau of Mines also authorized a \$4,413,250 gas synthesis Fischer-Tropsch process demonstration plant near Louisiana, Mo., to produce oil from coal. This is the third of the demonstration or semi-commer-

Typical of the cover type annealing furnaces being installed is this one designated to hold 8 stacks of cold reduced coils.

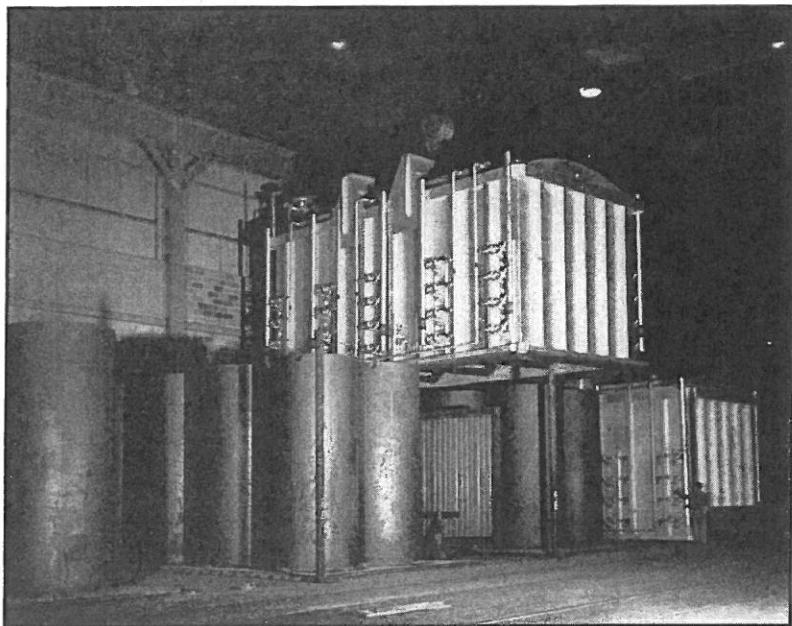

cial scale plants planned under the synthetic fuels research and development program of the Bureau of Mines. This plant will have a capacity of 80 bbls of oil a day and will include a coal gasification unit. The plant is adjacent to the Bureau's hydrogenation (Bergius process) demonstration plant also near Louisiana, Mo.

Because of the seasonal shortages in natural gas, several plants have set up standby systems for supplying fuel. A number of expedients have been used which include accessory oil burning equipment, petroleum auxiliary systems and auxiliary gas producing plants. One such gas generator which has been developed for use in the steel industry is a small unit which produces gasoline. This gasifier consists of two castings assembled together to form a combustion chamber with spark plug ignition. Fuel is admitted through a valve which provides control of the gas generation. The unit is about 6 in. high, 4 in. long and 3 in. wide, and has no moving parts. Its capacity varies from a minimum of almost 1,000 Btu to a maximum of 1,500,000 Btu per hour. The advantages of this installation are the small space requirements, low cost and instant availability.

Further work on the unmined coal gasification which was reported last year continued in Alabama. The experiment is being carried out in similar coal seams 100 to 125 ft down. Higher air pressures are being used, and it is expected that the Btu content of the gas will be increased from the 50 obtained last year to 150 in the next experiment.

The demand for natural gas reached new peaks during the year, principally because its cost went down in comparison with other fuels. Fortunately the reserves during 1947 increased by more than five trillion cu ft and total reserves at the beginning of 1948 were near one hundred sixty-six trillion ft. As a result, there has been a very heavy program of pipe line construction in order to transmit this gas to the industrial east.

During the year the first catalytic cracking plant to attain full commercial production for a utility began delivering gas to the distribution mains of the Long Island Lighting Co. This unit was installed to meet winter peak loads, and offers possibilities for many other industries. The plant is flexible in operation and compact in size. The principal item of equipment is the catalytic cracking furnace which breaks down the hydrogen-carbon vapor into a fixed gas. At the Long Island installation, gas of 240 Btu is obtained. This then is enriched to 540 Btu. The base feed stock is propane; gasoline casing head products can be used.

A new rotary heating furnace at a pipe mill in the Chicago area is the only one of its kind which has separate heating zones. The circular kiln has an outside diameter of 61 ft and an inside radius of 19 ft. Temperature in each heating zone can be controlled independently of the others. The facilities are particularly adapted to the production of tubing.

A roller-hearth furnace is accomplishing in one operation what previously required seven. Up to now, pickling was the only method known for treating and preparing metal surfaces for porcelain enameling. This furnace turns out a product surface which is not only superior to that obtained by pickling, but in some ways is superior.

etic  
he B  
of o  
ation  
rogen  
near l  
  
al gas  
suppl  
l whic  
oleum  
ing pl  
loped  
assem  
with  
alve  
it is a  
no mo  
of alm  
The ad  
ce req  
  
tion w  
a. The  
seams  
used  
will b  
in the  
  
peaks  
nt dow  
ie reser  
million  
were ne  
there  
struction  
ast.  
g plant  
lity be  
the L  
d to m  
many  
d compe  
e cata  
rogen  
d instal  
enriched  
soline  
  
mill in  
h has  
an out  
Temp  
independ  
rly ad  
  
one op  
now. P  
g and  
This  
only re  
e way  
  
UARY,



These slag pots in a southern mill are being dumped by means of compressed air instead of by steam as used to be normal practice. Since this train is run by a diesel locomotive a special car is attached to the locomotive which compresses air for operation of the slag pots.

## MATERIALS HANDLING

Conveyors, lift trucks, cranes and other special devices are being used to an ever-increasing degree in steel plant operations. The heavier and larger coils and other items required for operational economies and high speed production need much such equipment. In selecting such equipment, the question of economical size coils is a difficult one to analyze. For efficient mill operation, it is most desirable to run as large a unit as possible, but the resultant coil sizes are in turn limited, however, by the materials handling equipment. The industry wants to use heavier coils, even up to 60,000 or 75,000 lb. Whether cranes, conveyors or truck should be used is dependent on the local layout, allowable floor loads, and operational plan.

What is thought to be the heaviest pallet-type conveyor system ever built for coils was installed in connection with the new 70 miles-per-hour strip mill in the Pittsburgh district, moving coils from pickling lines to coil storage and feeding the mill. Industrial trucks are used for the intervening move.

The new 5-stand cold strip mill at Weirton features an unusual overhead coil conveyor. In this installation the coils coming from the 60 in. pickler are lowered by a turndown onto a short roller table and moved to the charge end of the overhead conveyor which takes them to the tandem mill. Each coil has its own individual car. The use of the overhead conveyor saves space.

Chain conveyors, in lengths of 1000 ft or more, are now designed for hot mill coils whose weights run up to 30,000 lb. Since coils for cold mills are increasing in weight, it has been recommended that they be handled by a troughed roller conveyor which will operate by a single chain equipped with knockover pusher dogs, with final travel on a feeder conveyor of the platform or pallet type.

One of the biggest changes in materials handling in the open-cut ore mines in the Superior district has been the use of the belt conveyors to handle the iron ore. It has proved cheaper and more efficient than the rail-haulage system previously used.

Two enormous cranes operating on one runway were installed during the year for the Navy at Hunters Point, San Francisco. These are the largest in the world. The cranes have a 142 feet span and the girders are 22

feet deep. These two cranes can work together through a lifting beam to form the world's largest crane, lifting loads up to 630 tons. The cranes are arranged so that they can be coupled together electrically as well as by means of standard car couplings so that they can be moved along the runway as one unit.

An item which will save time in materials handling, as well as making better records available, is a weighing device which can be attached to a crane hook. It is claimed that loading time can be reduced as much as  $\frac{2}{3}$ , and weights can be determined in spots not now practical.

Thirteen new mixer-type hot metal cars were installed during the year at one steel plant. These cars which were built to carry 200 tons of molten iron ore are the largest used in the steel industry. They operate on a short haul between the blast furnaces and bessemer converters.

The diesel engine is finding increasing favor in steel plant operation, and the steam locomotive is apparently on the way out. As a matter of fact, one of the largest manufacturers of locomotives discontinued the production of steam locomotives in the past year. On the other hand, there is development work underway on steam locomotives. The geared turbine locomotive will probably find its place in railroad operations, although not in the steel plant. Other work being done at the present time is the development of better boilers to reduce steam consumption and it now appears possible that steam consumption per horsepower hour may be cut 30 per cent with fuel reductions of 50 per cent. The gas turbine is also being developed for railroad use, but it also is apparently best for regular railroad service.

A new ore and coal dock was completed at Toledo, Ohio in the past year which will expedite the handling of coal and ore at this port. Among the unusual features is a coal dumping device which is electrically operated and which can dump loaded coal cars at the rate of one a minute. These docks are served by two ore unloading machines, each of which can unload ore at the rate of 30 tons per minute and there are three coal dumping machines.

The problem of unloading frozen coal is solved by an electric vibrating unit that is used to empty frozen coal at a steel plant. This unit, which sets up harmonic vibrations of over 1000 impulses per minute, will complete the coal-loosening operation in two to five minutes compared to the 15 to 60 minutes if manual labor is used.

## MECHANICAL DEVELOPMENTS

The first gas turbine to be bought by an electric utility was purchased during 1948. It is a 3500-kw turbine generator, and will be operated on natural gas which is available on the site. The unit has an in-line arrangement of compressor and combustion chambers, and will be geared to a conventional 3600-rpm, totally enclosed generator. The only water required for operation will be a small quantity for cooling the bearing lubricating oil and for cooling the a-c generator. Two 5000-kw, high efficiency gas turbine power plants were also ordered



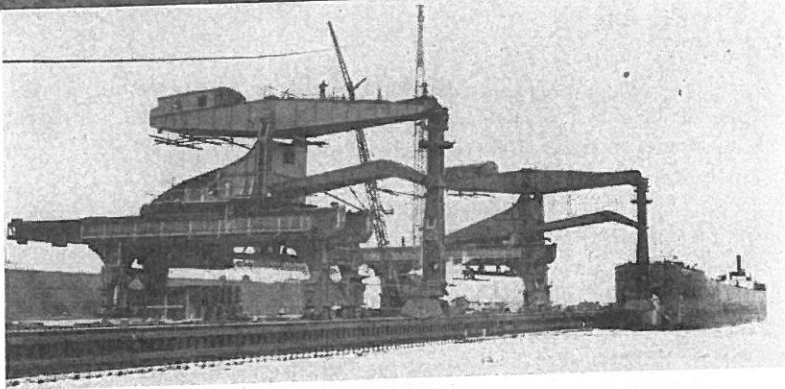

Two huge ore unloading machines serve the new coal and ore dock at Toledo, Ohio.

during the year. They will utilize intercooling and regenerative heat-transfer surfaces to recover waste heat. Proposals are now being considered for gas turbines for units of 20,000-kw full load capacity and 1100 F turbine inlet temperature.

Several power plants completed during the year reached a new top steam temperature of 1050 F. At one plant this is being used in a 100,000-kw turbogenerator, and another unit using this temperature is a three-casing 150,000-kw cross compound machine. These units are in utility stations. At these temperatures every 50 degrees rise decreases the amount of coal required by about 1.4 per cent. This new turbine produces 2500-kwhr for each ton of coal burned. With this new peak in temperatures, the recent trend away from reheat cycles is being reversed, and some of the newer units are being designed for reheat.

One turbine manufacturer is making the larger stationary, low pressure blades hollow, which results in worthwhile economy of material since they are made of stainless.

The first post-war mercury unit power plant went into operation in New England as a topping plant, producing 15,000 kw from the mercury turbine generator. It also provides some 200,000 pounds of steam at 400 psi pressure to drive existing steam turbines.

There has been a definite increase in the development of packaged boiler units in the small sizes. These are produced with all accessory equipment ready to be placed on the job and connected.

One item developed during the year which will be useful in maintenance of power plants is a portable electronic instrument which, when pushed through a tube, will chart the condition of the metal and locate such defects as pinholes and scale. The instrument is now available for spotting defects in non-magnetic tubes.

A new use for television is creeping into the industry. At one power generating station, a television set is used to read gages which are located at the top of the boilers.

The power plant of the future may be a basic processing center. An installation may consist of coal being burned underground, forming a gas product which in turn may be synthesized into liquid fuels and by-products. Gas and steam turbines may in turn then generate power which will be transmitted by power line. The gas produced may in turn also be transmitted by pipe line. Thus, the materials handling cost of coal may be completely eliminated. From present indications power plants, based on atomic energy, are apparently far from practical realization.

A new process for the manufacture of relatively pure

oxygen in tonnage quantities was announced during the year. Pilot plant operations have demonstrated that the process can operate without the necessity of periodic "defrosting" shutdowns. In this process, preconditions air is cooled to below  $-300$  F and distilled in a distillation column into its components, oxygen and nitrogen. The oxygen is then piped to its place of use. The nitrogen is pure enough to be used as a chemical raw material or for bright annealing in steel mills. It is estimated that plants can be built which will produce more than 25,000,000 cu ft (1000 tons) of oxygen per day. The heart of the process (which is low pressure system) is a turbo-expander which is essentially a small, high-speed radial flow turbine, whose principal function is to produce refrigeration at the low temperature levels required for the distillation of air into its components. Useful power is developed as a by-product. The pilot plant produces 95 per cent pure oxygen. It is claimed that the system is completely immune to dangers of acetylene explosions, and will operate at reduced loads without sacrifice of efficiency. The system is mechanically simple and all controls are automatic. Oxygen can also be made as pure as 99.5 per cent. Maximum pressure is about 5 psi.

A recent welding development uses an inert gas, argon, for spot welding. The weld is produced from an electric arc applied to the top surface of two lap pieces of metal. One unusual feature is that the weld can be done entirely from one side, and access to the other side is not necessary.

Of particular interest to strip mill operators is a welding machine that heats the ends of hot rolled strip steel to a plastic state and then forges them together with an upsetting impact having a pressure up to 12,000 psi. The welding time is about 10 seconds and the resulting weld can be cold reduced with the rest of the strip. The mechanical operations of the welder are hydraulically actuated, and electronic controls limit the current during the welding cycle. The flash from the weld is shaved off in a special trimmer.

Another new welding method developed during the year is cold pressure welding. This method at present is best adapted to aluminum and copper, although other metals can be cold-welded. There are two important items in this process. One is preparation of the surfaces and it is essential that the two surfaces which are brought into contact be entirely uncontaminated. The second requirement is that the pressure be applied over a comparatively narrow strip so that the metal can be drawn away from the weld at both sides. This is achieved by applying the pressure between specially designed dies. Pressures required are in the region of between 24,000 and 36,000 psi for aluminum, and for copper they should be three or four times these values. These pressures should be sufficient to set up plastic flow of the materials to be welded.

The new strip mills have some unusual lubrication features. One of the most recent installations has a special recirculating oil system for the back-up rolls, and a similar system for the drives and screwdowns. Another system handles the palm oil. Two 14,000 gallon tanks are used in the system for the back-up bearings and contain steam coils to maintain a temperature of 110 F. The system for the pinions is similar, with extra pressure oil kept in a 8000 gallon tank and circ-

ated by 200 gpm pumps. Grease pumps supply extreme pressure lubricant to the work roll bearings at definite time intervals and in definite amounts. The palm oil and water are mixed in a tank and pumped to the roll by 42 pumps. The palm oil is then recovered for reuse. One unusual feature is the automatic fire control apparatus which is installed in the oil cellar. This system will flood the entire area with two tons of carbon dioxide for a period of two minutes.

On November 18, delegates from the United States, United Kingdom, and Canada signed an agreement on unification of the American and British standard systems of screw threads. The present unification agreement uses a 60 degree angle and a rounded root for screw threads. The crest of the external thread may be flat, as preferred in American practice, or rounded as preferred by the British. The number of threads per inch for the various series has been standardized and the limiting dimensions for three grades of thread have been agreed upon. Thus, interchangeability of screw thread parts now becomes feasible.

The old British or Whitworth system was based on a thread angle of 55 degrees with a thread form having round crests and roots. The American Sellers System had a thread angle of 60 degrees with a thread form having flat crests and roots. There is little change in the number of threads per inch but a new 1/2 in. coarse thread has been added which has 12 threads per in. in addition to the one which has 13 threads per in.

The open hearth fume problem, which has been particularly troublesome with oxygen, has been substantially overcome in one plant by the use of a scrubbing device for cleaning stack gases. The unit is a venturi scrubber and it is said to be 95 to 99 per cent efficient in iron oxide fume removal. The fume is highly magnetic and has a mean particle size ranging between 0.115 and 0.183 microns. The method consists basically of a means of injecting low velocity liquid into a high velocity stream of dirty gas. The gas impinges upon and dis-

rupts the liquid, and much of the liquid is finely atomized. The mixture of gas and spray is then decelerated and separated, at which time the liquid contains most of the solids.

In maintenance work, chrome plating of worn parts has been found to increase the wear resistance appreciably and is being used in a number of steel mill applications.

Carbide roll roughing and finishing tools have been developed which decrease markedly the time required in turning and refinishing hard rolls. A number of special shapes are used to expedite the different operations.

Tests during the year have proved that it is practical to inspect heavy steel billets with the betatron to determine the exact depth of the end shrinkage flaw or "pipe." Thus, the machine may be used so as to eliminate wasteful remelting of thousands of tons of steel. A 10,000,000-volt betatron was installed during the year at the Naval Laboratory. It can X-ray rolled steel 10 in. thick at a distance of six ft. in 30 minutes. This is eight times the speed obtained with 2,000,000 volt equipment.

#### ELECTRICAL DEVELOPMENTS

The figures for power consumption released in 1948 for the year 1947 showed that the nation's steel industry used a total of 23,000,000,000 kwhr of electricity, averaging 275 kwhr for each ton of steel, and it is believed that this consumption will increase. As one example of the increased power which will probably be required by the steel industry, it has been estimated that the beneficiation of low grade ores may require as much as 70 kwhr per ton of ore, compared with the present average of 4.5 kwhr. One of the largest single power consumers in the country is the arc furnace. The present installed capacity is about 3,000,000 kw and this figure is growing rapidly.

The most outstanding engineering developments and trends in the electrical industry for 1948 were those in the field of power production. Public utility companies are expected to spend about \$16,000,000,000 for new and improved generating and distribution facilities within the next ten years. Thus, production of electric power in this country will be increased from slightly over 282,000,000,000 in 1948 by the utility companies to 430,000,000,000 kwhr with an increasing expansion of generating capacity in this country from 56,000,000 at the end of 1948 to over 95,000,000 kw. In addition industrial plants generated 54,000,000,000 kwhr for their own use.

The electric manufacturers have standardized on six preferred ratings for large 3600 rpm condensing turbo-generator units. These ratings are 11,500, 15,000, 20,000, 30,000, 40,000, and 60,000 kw. The two larger sizes are available for steam conditions of either 850 psi at 900 F or 1250 psi at 950 F. About 85 per cent of the turbo-generator units being ordered are designed to operate at 3600 rpm and about 93 per cent are hydrogen-cooled.

Most of the tandem cold reducing strip mills now being built are arranged so that each of the mill drive motors is fed from a separate generator. Although this system requires more complex regulating control than the high current booster generator, they afford greater flexibility in making up rolling schedules as the motor

The short stroke dancer roll control system is essentially a phase shift rectifier which is capable of producing a variable rectified d-c output voltage.

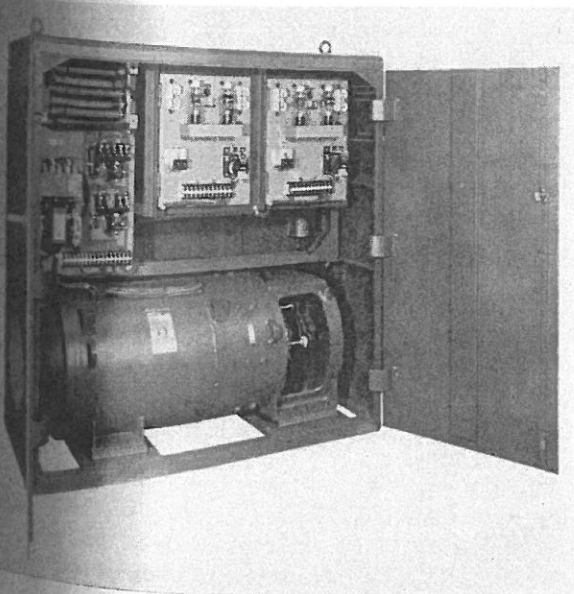



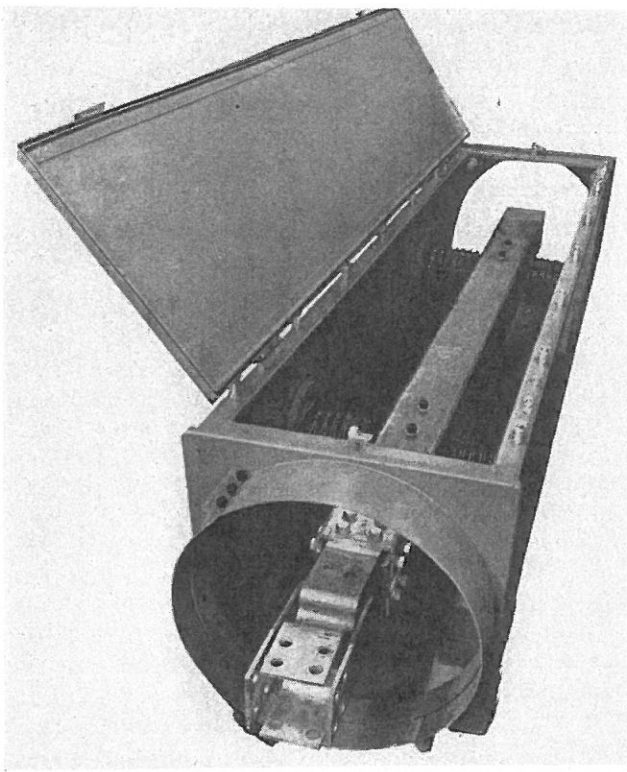

**This metal enclosed bus can carry 15 kv, 4000 amperes.**

speed ranges may be extended by operating some of them at reduced voltage.

One of the fastest existing electric-tinning lines has been given a greater capacity by the addition of 300 kw of 9600-cycle induction heating for flow-brightening.

To measure roll screwdown setting accurately, a large Southern mill is applying a d-c positioner as a differential 20-in. dial indicator. The system operates from the d-c supply driving the screwdown motors, thus preventing the indicator from getting out of step in the event of a power interruption.

The use of X-ray thickness gages has been found to increase sheet output of prime sheets. There is no contact with the material. Several of the new tinplate mills have been equipped with these gages.

Mercury arc rectifiers are being given serious consideration as a power supply for hot strip finishing mill motors. A hot strip mill is now being built for France whose six finishing stand motors with a total of 23,000

**Illustrated here is a new gear motor which went into production in the past year.**

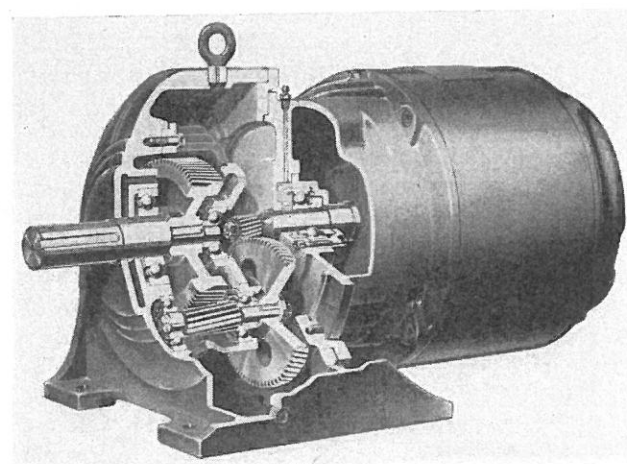

hp will be supplied by three 5000-kw rectifiers. On a mill to be modified at a West Coast plant, rectifiers alone will be used for full adjustable voltage control of a continuous hot strip mill. Two mercury arc rectifiers, each rated 4000-kw, 600-volt (5000 kw with transformer fans), will supply power to the finishing train motors. These rectifiers will be used to start the mill motors from rest by phase retard. The output of each rectifier will be regulated by either a new magnetic amplifier or amplystats.

One of the largest pump-evacuated frequency changing installations in the country will operate in a mid-western steel mill with the re-rating to 8000 kw of a 6600 kw, 25/60 cycle mercury arc system installed in 1944.

A new rod mill installed in a middle west steel plant has a number of unusual features. This mill delivers two rods simultaneously from 19 stands set in tandem. Rod sizes range from No. 5 to  $\frac{3}{4}$  of an inch and are made from hot billets up to  $2\frac{1}{2}$  in. square and 40 ft in length. Nine d-c motors with total of 3900 hp and three 1000-kw generators provide a flexible driving arrangement. Since the stands in this mill were placed much more closer together than is the usual practice, more accurate speed regulation was required. Fly wheel effect was added to the motors and instantaneous speed regulation is nearly obtained by quick acting-rotating regulators. The overall speed of the mill is set by a reference bus under the control of a master pilot generator. Each driving motor is equipped with a pilot generator and any change in motor speed is transmitted to the electronic amplifier. The signal is passed along at a higher voltage to a rotating regulator booster which then changes the motor speed by the right amount. The electronic regulator is designed for a sensitivity of linear response of plus or minus 0.2 of a volt with an available amplification of 450 to 500. Three motors in the stands have the same arrangement except that speed correction is obtained by a direct-acting rotating regulator in the shunt field circuit.

The magnetic amplifier has developed from a laboratory device to actual use in the steel plant. It is a static amplifier and is based on the principle of a d-c saturable reactor where a small input signal can be used to control a relatively large output signal. It will undoubtedly take the place of rotating regulators or electronic amplifiers in many regulating circuits and will undoubtedly be applied in conjunction with the rotating regulator in many others.

Variable voltage drives have been applied to continuous strip pickling lines to provide smoother control and higher speed. The entry end and the delivery end are operated on separate systems so that the delivery end may operate practically continuously, slowing down or stopping only briefly to shear the strip and to charge the completed large coils. The entry end, on the other hand, operates intermittently starting new coils, shearing the ends square, and joining the ends by flash welding. One pickling line now in operation is designed for 700 fpm maximum strip speed through the pickling tanks, with an entry end speed of 1400 fpm maximum.

Three of the world's highest rated kva transformers were constructed during the year. They are not the largest in size because of the corasil steel used for magnetic cores and the forced-directed flow of the cooling

s. On  
ifiers  
ol of a  
tifiers.  
ransfo  
ain mo  
mill m  
ch rec  
amplif

ncy ch  
e in a  
w of a  
ed in  
steel p  
livers  
ndem.  
d are m  
t in len  
three l  
ranger  
much m  
re accur  
effect  
eed reg  
otating  
by a r  
genera  
t genera  
tted to  
along a  
ster w  
nount  
ty of lin  
n avail  
the stan  
eed com  
g regula

n a labo  
t is a st  
e satur  
sed to c  
doubt  
tronic  
l undou  
ting reg

to con  
ter com  
livery m  
e deliv  
y, slow  
ip and  
nd, on  
g new  
e ends  
tion is  
rough  
1400

nsform  
e not  
l for m  
he cool

UARY, 19

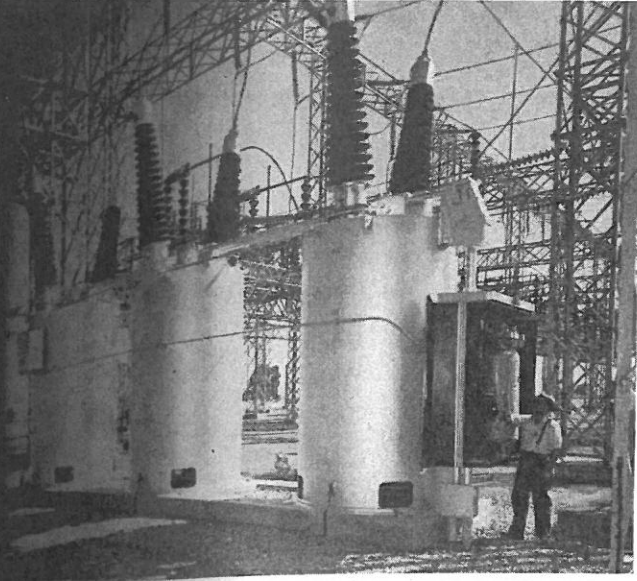

These oil circuit breakers have a capacity of 230 kv and are installed on the lines of a western utility company.

liquid. The voltage range is from 15,000 to 135,000, and each are rated three-phase, 145,000 kva.

A new line of low voltage (600 v) current transformers was developed during the year. It is claimed that this new transformer can maintain accuracy at 60 per cent overload without overheating.

Switchgear developments during the year emphasized completely co-ordinated factory-built equipments. There was also a large increase in the interrupting ratings of commercial voltage power circuit breakers. Nine factory-built 230-kv switchgear units were designed with an interrupting rating of 10,000,000 kva without increase in the physical size of the breakers. The highest rating previously available was 3,500,000 kva. These units will control the output of the nine 108,000 kv generators in the north power house of Grand Coulee power projects. The increase in rating was accomplished by using the multiflow deionization grid principle developed for high voltage.

A new line of high current contactors, rated at 1500,

The cumulative curve of main drive motors over 300 hp shows a total to January 1, 1949 of 5,266,090 hp. One hundred four motors (137,800 hp) were added in 1948.

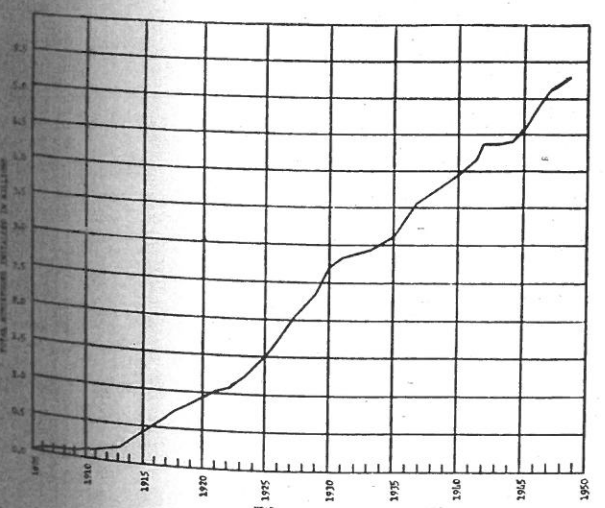

3,000, and 6,000 amp at 750 volts, was developed primarily for mill applications.

Several new high-pressure gas-filled cables of the pipe type and mass-impregnated construction were installed for high voltage during the year.

A new gearmotor was introduced last year which has an unusually compact design. These motors are built in six basic sizes capable of delivering 1 to 60 hp. These are helical type, horizontal units and are completely integral a-c or d-c motors with flange mounting and operate from 71½ to 780 rpm. Single, double, and triple reduction units are available in each size.

Clamp type linings were introduced during the year for use on magnetic brakes for mill and heavy duty service. The construction gives a brake lining which is smooth, has a large braking area, gives longer wear, and can be changed without removing the shoe from the brake.

A new device developed during the year provides a simple way of measuring extremely heavy direct currents. Instead of the usual large shunt, a special current transformer of the through type is used whose secondary winding is energized by alternating current at some convenient low potential. A change in the direct current affects the reluctance of the magnetic circuit and in turn the current flowing in its a-c circuit. This a-c current is then measured on the conventional ammeter calibrated in terms of the d-c current in the heavy bus. The scheme is accurate to ½ per cent.

Magnetic suspension of the moving element is the outstanding feature of a single-phase watt-hour meter introduced during the year. A cunico magnet is attached to the frame and another is an integral part of the disk-and-shaft assembly. Interaction of the two magnetic fields supports the moving systems in a state of equilibrium. The new meter has longer life, improved performance, and lowered maintenance cost.

One of the interesting electrical developments has been the application of printed electrical circuits. Printed components such as capacitors and resistors are available which reduce equipment costs very markedly. So far the development has been applied primarily for circuits for communication work and low loss, and high-stability capacitors. The process is based on laying down by spraying layers of vitreous enamel, alternating with layers of conductive silver paste deposited by silk screen or squeegee printing. The ceramic dielectric has a loss factor of the same order as mica. The properties of silver are such that high electrical conductivity is obtained. The units can be made very small.

Interest has been aroused in this country in the nickel-cadmium batteries, using an alkaline bath. This battery has been used for a long time in Europe but has only recently been introduced in this country. It is claimed that they will last three times longer than present type batteries.

One interesting X-ray machine developed during the year was a super-speed motion picture camera. This equipment takes X-ray exposures of 10 millionths of a second, using a shutterless camera shooting movies at 100 frames a second. The machine offers vast possibilities for the research worker in studying and observing physical phenomena.