



Preise: (exkl. Wust, Porto und Verpackung)

1 - 24 St. Fr. 226.--/St.

25 - 99 St. Fr. 175.--/St.

100 - 999 St. Fr. 157.--/St.

2716

16K (2K×8) UV ERASABLE PROM

- Single +5V Power Supply
- Simple Programming Requirements
Single Location Programming Programs With One 50ms Pulse
- Low Power Dissipation
525mW Max. Active Power
132mW Max. Standby Power
- Pin Compatible To Intel 2316E ROM
- Fast Access Time: 450ns Max.
- Inputs and Outputs TTL
Compatible During Read And Program

The Intel® 2716 is a 16,384-bit ultraviolet erasable and electrically programmable read-only memory (EPROM). The 2716 operates from a single 5-volt power supply, has a static power down mode, and features fast single address location programming. It makes designing with EPROMs faster, easier and more economical. For production quantities, the 2716 user can convert rapidly to Intel's new pin-for-pin compatible 16K ROM, the 2316E.

Since the 450-nsec 2716 operates from a single 5-volt supply, it is ideal for use with the newer high performance +5V microprocessors such as Intel's 8085 and 8048. The 2716 is also the first EPROM with a static power down mode which reduces the power dissipation without increasing access time. The maximum active power dissipation is 525 mW while the maximum standby power dissipation is only 132 mW, a 75% savings.

The 2716 has the simplest and fastest method yet devised for programming EPROMs — single pulse TTL level programming. No need for high voltage pulsing because all programming controls are handled by TTL signals. Now, it is possible to program on-board, in the system, in the field. Program any location at any time — either individually, sequentially or at random, with the 2716's single address location programming. Total programming time for all 16,384 bits is only 100 seconds.

PIN CONFIGURATION

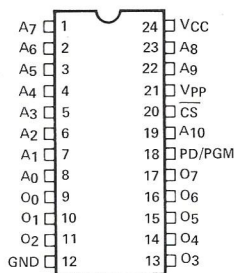

PIN NAMES

A ₀ –A ₁₀	ADDRESSES
PD/PGM	POWER DOWN/PROGRAM
CS	CHIP SELECT
O ₀ –O ₇	OUTPUTS

MODE SELECTION

MODE \ PINS	PD/PGM (18)	CS (20)	V _{PP} (21)	V _{CC} (24)	OUTPUTS (9-11, 13-17)
Read	V _{IL}	V _{IL}	+5	+5	D _{OUT}
Deselect	Don't Care	V _{IH}	+5	+5	High Z
Power Down	V _{IH}	Don't Care	+5	+5	High Z
Program	Pulsed V _{IL} to V _{IH}	V _{IH}	+25	+5	D _{IN}
Program Verify	V _{IL}	V _{IL}	+25	+5	D _{OUT}
Program Inhibit	V _{IL}	V _{IH}	+25	+5	High Z

BLOCK DIAGRAM

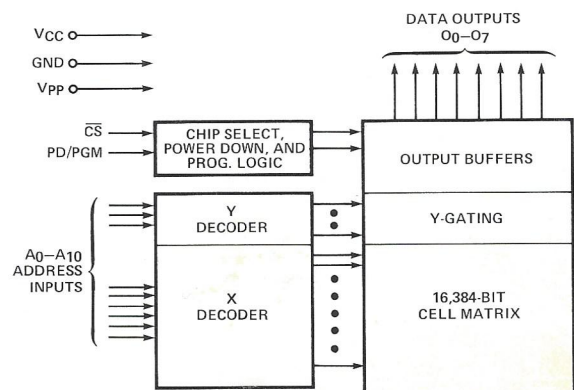

Absolute Maximum Ratings*

Temperature Under Bias -10°C to +80°C
 Storage Temperature -65°C to +125°C
 All Input or Output Voltages with Respect to Ground +6V to -0.3V
 V_{PP} Supply Voltage with Respect to Ground +28V to -0.3V

**COMMENT:* Stresses above those listed under "Absolute Maximum Ratings" may cause permanent damage to the device. This is a stress rating only and functional operation of the device at these or any other conditions above those indicated in the operational sections of this specification is not implied. Exposure to absolute maximum rating conditions for extended periods may affect device reliability.

READ OPERATION

D.C. and Operating Characteristics

T_A = 0°C to 70°C, V_{CC}^[1,2] = +5V ±5%, V_{PP}^[2] = V_{CC} ±0.6V^[3]

Symbol	Parameter	Limits			Unit	Conditions
		Min.	Typ. ^[4]	Max.		
I _{LI}	Input Load Current			10	μA	V _{IN} = 5.25V
I _{LO}	Output Leakage Current			10	μA	V _{OUT} = 5.25V
I _{PP1} ^[2]	V _{PP} Current			5	mA	V _{PP} = 5.85V
I _{CC1} ^[2]	V _{CC} Current (Standby)		10	25	mA	PD/PGM = V _{IH} , $\overline{CS} = V_{IL}$
I _{CC2} ^[2]	V _{CC} Current (Active)		57	100	mA	$\overline{CS} = PD/PGM = V_{IL}$
V _{IL}	Input Low Voltage	-0.1		0.8	V	
V _{IH}	Input High Voltage	2.2		V _{CC} +1	V	
V _{OL}	Output Low Voltage			0.45	V	I _{OL} = 2.1 mA
V _{OH}	Output High Voltage	2.4			V	I _{OH} = -400 μA

- NOTES:**
1. V_{CC} must be applied simultaneously or before V_{PP} and removed simultaneously or after V_{PP}.
 2. V_{PP} may be connected directly to V_{CC} except during programming. The supply current would then be the sum of I_{CC} and I_{PP1}.
 3. The tolerance of 0.6V allows the use of a driver circuit for switching the V_{PP} supply pin from V_{CC} in read to 25V for programming.
 4. Typical values are for T_A = 25°C and nominal supply voltages.
 5. This parameter is only sampled and is not 100% tested.
 6. t_{ACC2} is referenced to PD/PGM or the addresses, whichever occurs last.

Typical Characteristics

I_{CC} CURRENT vs. TEMPERATURE

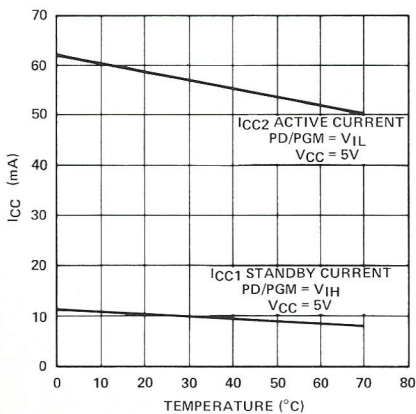

ACCESS TIME vs. CAPACITANCE

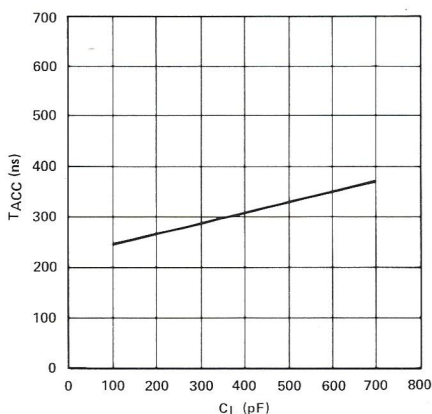

ACCESS TIME vs. TEMPERATURE

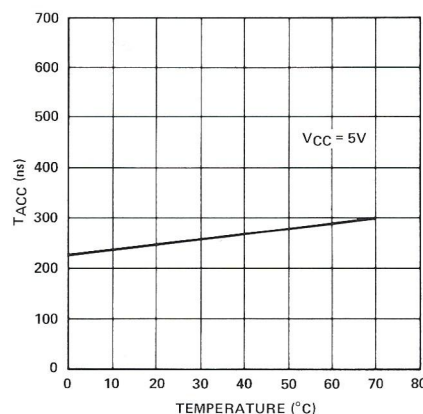

A.C. Characteristics

$T_A = 0^\circ\text{C}$ to 70°C , $V_{CC}^{[1]} = +5\text{V} \pm 5\%$, $V_{PP}^{[2]} = V_{CC} \pm 0.6\text{V}^{[3]}$

Symbol	Parameter	Limits			Unit	Test Conditions
		Min.	Typ. ^[4]	Max.		
t_{ACC1}	Address to Output Delay		250	450	ns	$\overline{\text{PD}}/\text{PGM} = \overline{\text{CS}} = V_{IL}$
t_{ACC2}	PD/PGM to Output Delay		280	450	ns	
t_{CO}	Chip Select to Output Delay			120	ns	$\overline{\text{PD}}/\text{PGM} = V_{IL}$
t_{PF}	PD/PGM to Output Float	0		100	ns	
t_{DF}	Chip Deselect to Output Float	0		100	ns	$\overline{\text{PD}}/\text{PGM} = V_{IL}$
t_{OH}	Address to Output Hold	0			ns	$\overline{\text{PD}}/\text{PGM} = \overline{\text{CS}} = V_{IL}$

Capacitance^[5] $T_A = 25^\circ\text{C}$, $f = 1\text{ MHz}$

Symbol	Parameter	Typ.	Max.	Unit	Conditions
C_{IN}	Input Capacitance	4	6	pF	$V_{IN} = 0\text{V}$
C_{OUT}	Output Capacitance	8	12	pF	$V_{OUT} = 0\text{V}$

NOTE: Please refer to page 2 for notes.

A.C. Test Conditions:

Output Load: 1 TTL gate and $C_L = 100\text{ pF}$

Input Rise and Fall Times: $\leq 20\text{ ns}$

Input Pulse Levels: 0.8V to 2.2V

Timing Measurement Reference Level:

Inputs 1V and 2V

Outputs 0.8V and 2V

WAVEFORMS

A. Read Mode

$\overline{\text{PD}}/\text{PGM} = V_{IL}$

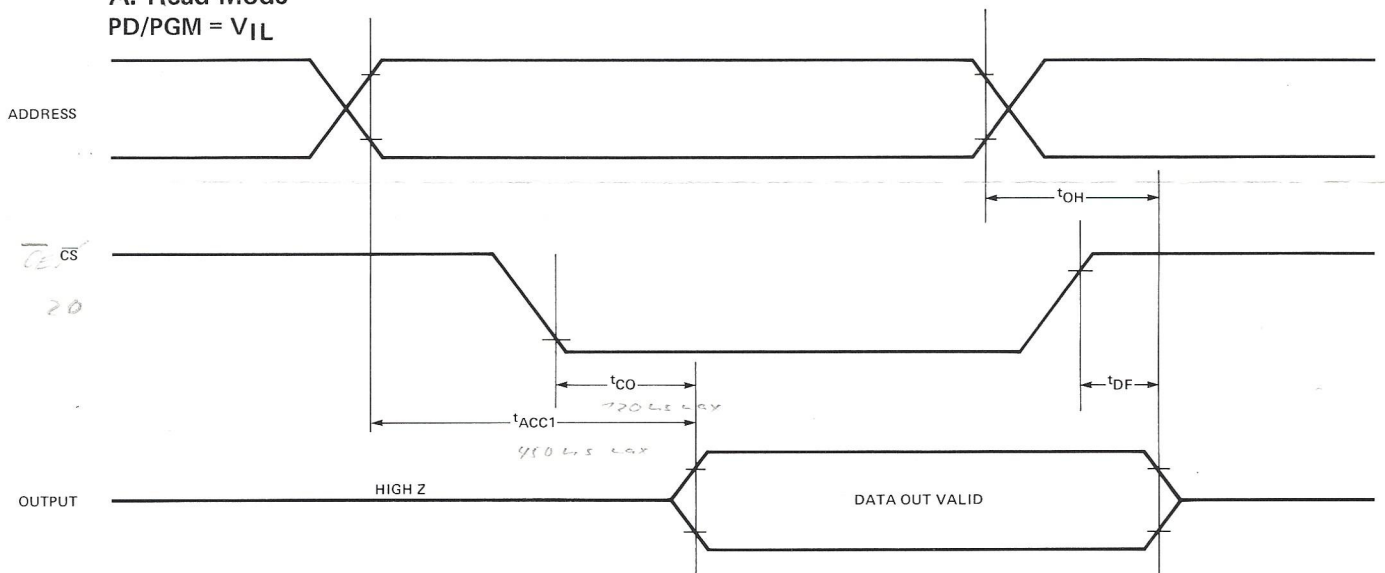

B. Standby Mode

$\overline{\text{CS}} = V_{IL}$

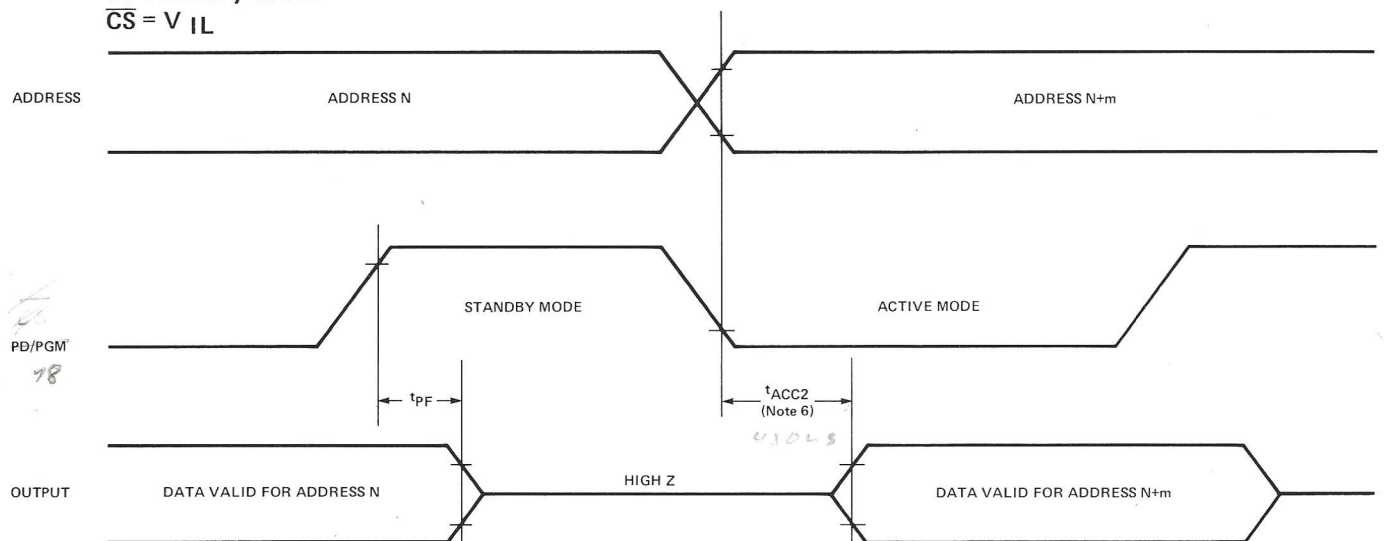

ERASURE CHARACTERISTICS

The erasure characteristics of the 2716 are such that erasure begins to occur when exposed to light with wavelengths shorter than approximately 4000 Angstroms (\AA). It should be noted that sunlight and certain types of fluorescent lamps have wavelengths in the 3000–4000 \AA range. Data show that constant exposure to room level fluorescent lighting could erase the typical 2716 in approximately 3 years, while it would take approximately 1 week to cause erasure when exposed to direct sunlight. If the 2716 is to be exposed to these types of lighting conditions for extended periods of time, opaque labels are available from Intel which should be placed over the 2716 window to prevent unintentional erasure.

The recommended erasure procedure for the 2716 is exposure to shortwave ultraviolet light which has a wavelength of 2537 Angstroms (\AA). The integrated dose (i.e., UV intensity \times exposure time) for erasure should be a minimum of 15 W-sec/cm². The erasure time with this dosage is approximately 15 to 20 minutes using an ultraviolet lamp with a 12000 $\mu\text{W}/\text{cm}^2$ power rating. The 2716 should be placed within 1 inch of the lamp tubes during erasure. Some lamps have a filter on their tubes which should be removed before erasure.

DEVICE OPERATION

The six modes of operation of the 2716 are listed in Table I. It should be noted that all inputs for the six modes are at TTL levels. The power supplies required are a +5V V_{CC} and a V_{PP} . The V_{PP} power supply must be at 25V during the three programming modes, and must be at 5V in the other three modes.

TABLE I. MODE SELECTION

MODE \ PINS	PD/PGM (18)	\overline{CS} (20)	V_{PP} (21)	V_{CC} (24)	OUTPUTS (9-11, 13-17)
Read	V_{IL}	V_{IL}	+5	+5	D_{OUT}
Deselect	Don't Care	V_{IH}	+5	+5	High Z
Power Down	V_{IH}	Don't Care	+5	+5	High Z
Program	Pulsed V_{IL} to V_{IH}	V_{IH}	+25	+5	D_{IN}
Program Verify	V_{IL}	V_{IL}	+25	+5	D_{OUT}
Program Inhibit	V_{IL}	V_{IH}	+25	+5	High Z

READ MODE

Data is available at the outputs in the read mode. Data is available 450 ns (t_{ACC}) from stable addresses with \overline{CS} low or 120 ns (t_{CO}) from \overline{CS} with addresses stable.

DESELECT MODE

The outputs of two or more 2716s may be OR-tied together on the same data bus. Only one 2716 should have its outputs selected (\overline{CS} low) to prevent data bus contention between 2716s in this configuration. The outputs of the other 2716s should be deselected with the \overline{CS} input at a high TTL level.

POWER DOWN MODE

The 2716 has a power down mode which reduces the active power dissipation by 75%, from 525 mW to 132 mW. Power down is achieved by applying a TTL high signal to the PD/PGM input. In power down the outputs are in a high impedance state, independent of the \overline{CS} input.

PROGRAMMING

Initially, and after each erasure, all bits of the 2716 are in the "1" state. Data is introduced by selectively programming "0's" into the desired bit locations. Although only "0's" will be programmed, both "1's" and "0's" can be presented in the data word. The only way to change a "0" to a "1" is by ultraviolet light erasure.

The 2716 is in the programming mode when the V_{PP} power supply is at 25V and \overline{CS} is at V_{IH} . The data to be programmed is applied 8 bits in parallel to the data output pins. The levels required for the address and data inputs are TTL.

When the addresses and data are stable, a 50 msec, active high, TTL program pulse is applied to the PD/PGM input. A program pulse must be applied at each address location to be programmed. You can program any location at any time — either individually, sequentially, or at random. The program pulse has a maximum width of 55 msec. The 2716 must not be programmed with a DC signal applied to the PD/PGM input.

Programming of multiple 2716s in parallel with the same data can be easily accomplished due to the simplicity of the programming requirements. Like inputs of the paralleled 2716s may be connected together when they are programmed with the same data. A high level TTL pulse applied to the PD/PGM input programs the paralleled 2716s.

PROGRAM INHIBIT

Programming of multiple 2716s in parallel with different data is also easily accomplished. Except for PD/PGM, all like inputs (including \overline{CS}) of the parallel 2716s may be common. A TTL level program pulse applied to a 2716's PD/PGM input with V_{PP} at 25V will program that 2716. A low level PD/PGM input inhibits the other 2716s from being programmed.

PROGRAM VERIFY

A verify should be performed on the programmed bits to determine that they were correctly programmed. The verify may be performed with V_{PP} at 25V. Except during programming and program verify, V_{PP} must be at 5V.

2716 PROGRAM CHARACTERISTICS (1)

$T_A = 25^\circ\text{C} \pm 5^\circ\text{C}$, $V_{CC}^{[2]} = 5\text{V} \pm 5\%$, $V_{PP}^{[2,3]} = 25\text{V} \pm 1\text{V}$

D.C. Programming Characteristics

Symbol	Parameter	Min.	Typ.	Max.	Units	Test Conditions
I_{LI}	Input Current (for Any Input)			10	μA	$V_{IN} = 5.25\text{V}/0.45$
I_{PP1}	V_{PP} Supply Current			5	mA	PD/PGM = V_{IL}
I_{PP2}	V_{PP} Supply Current During Programming Pulse			30	mA	PD/PGM = V_{IH}
I_{CC}	V_{CC} Supply Current			100	mA	
V_{IL}	Input Low Level	-0.1		0.8	V	
V_{IH}	Input High Level	2.2		$V_{CC}+1$	V	

A.C. Programming Characteristics

Symbol	Parameter	Min.	Typ.	Max.	Units	
t_{AS}	Address Setup Time	2			μs	
t_{CSS}	$\overline{\text{CS}}$ Setup Time	2			μs	
t_{DS}	Data Setup Time	2			μs	
t_{AH}	Address Hold Time	2			μs	
t_{CSH}	$\overline{\text{CS}}$ Hold Time	2			μs	
t_{DH}	Data Hold Time	2			μs	
t_{DF}	Chip Deselect to Output Float Delay	0		120	ns	
t_{CO}	Chip Select to Output Delay			120	ns	PD/PGM = V_{IL}
t_{PW}	Program Pulse Width	45	50	55	ms	
t_{PRT}	Program Pulse Rise Time	5			ns	
t_{PFT}	Program Pulse Fall Time	5			ns	

- NOTES:**
- Intel's standard product warranty applies only to devices programmed to specifications described herein.
 - V_{CC} must be applied simultaneously or before V_{pp} and removed simultaneously or after V_{pp} . The 2716 must not be inserted into or removed from a board with V_{pp} at $25 \pm 1\text{V}$ to prevent damage to the device.
 - The maximum allowable voltage which may be applied to the V_{pp} pin during programming is +26V. Care must be taken when switching the V_{pp} supply to prevent overshoot exceeding this 26V maximum specification.

A.C. Conditions of Test:

V_{CC} 5V $\pm 5\%$
 V_{PP} 25V $\pm 1\text{V}$
 Input Rise and Fall Times (10% to 90%) 20 ns
 Input Pulse Levels 0.8V to 2.2V
 Input Timing Reference Level 1V and 2V
 Output Timing Reference Level 0.8V and 2V

PROGRAMMING WAVEFORMS

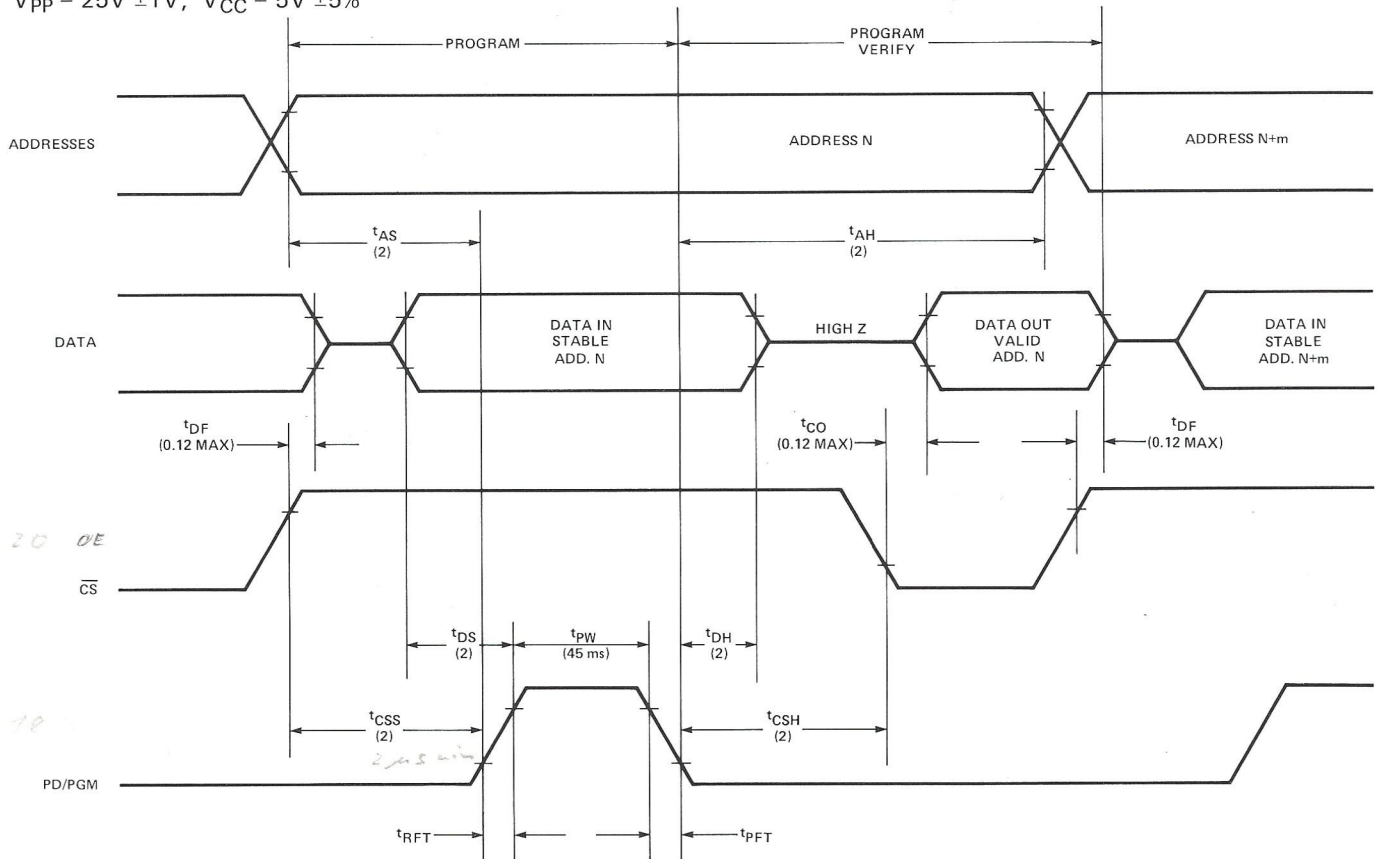
 $V_{PP} = 25V \pm 1V$, $V_{CC} = 5V \pm 5\%$

NOTE: ALL TIMES SHOWN IN PARENTHESES ARE MINIMUM TIMES AND ARE μ SEC UNLESS OTHERWISE NOTED.

Intel Corporation

3065 Bowers Avenue
 Santa Clara, California 95051
 Tel: (408) 246-7501
 TWX: 910-338-0026
 TELEX: 34-6372



U.S. REGIONAL SALES OFFICES

WESTERN

CALIFORNIA

Intel Corp.*
 1651 East 4th Street
 Suite 228
 Santa Ana 92701
 Tel: (714) 835-9642
 TWX: 910-595-1114

EASTERN

OHIO

Intel Corp.*
 8312 North Main Street
 Dayton 45415
 Tel: (513) 890-5350
 TELEX: 288-004

MID-WESTERN

ILLINOIS

Intel Corp.*
 1000 Jorie Boulevard
 Suite 224
 Oakbrook 60521
 Tel: (312) 325-9510
 TWX: 910-651-5881

ATLANTIC

MASSACHUSETTS

Intel Corp.*
 187 Billerica Road, Suite 14A
 Chelmsford 01824
 Tel: (617) 256-6567
 TWX: 710-343-6333

OVERSEAS MARKETING OFFICES

ORIENT

JAPAN

Intel Japan Corporation*
 Flower Hill-Shinmachi East Bldg.
 1-23-9, Shinmachi, Setagaya-ku
 Tokyo 154
 Tel: (03) 426-9261
 TELEX: 781-28426

EUROPE

BELGIUM

Intel International*
 Rue du Moulin à Papier
 51-Boite 1
 B-1160 Brussels
 Tel: (02) 660 30 10
 TELEX: 24814

*Field Application Location